

KALE III



www.kalemakina.com

Gücün Kalesi, Kale'nin Gücü!

HİKOKI

Gücün Profesyoneli, Profesyonelin Gücü!



KL PRO III

Gücün Ustası, Ustanın Gücü!



KL ECO III

Gücün Kullanıcısı, Kullanıcının Gücü!



2025

FİYAT LİSTESİ



- Akülüler
- Bataryalar
- Şarj cihazları

(2 - 11 sayfa)

1



- Matkaplar
- Darbeli somun sıkımlar

(12 - 14 sayfa)

2



- Avuç taşlamalar
- Büyük taşlamalar
- Polisajlar
- Kalıpcı taşlamalar

(15 - 17 sayfa)

3



- Kırıcı deliciler
- Kırıcılar

(18 - 20 sayfa)

4



- Daire testereler
- Profil kesme
- Gönye kesme
- Raylı gönye kesme
- Freze

(21 - 22 sayfa)

5



- Eksantrik zımpara
- Panya
- Sıcak hava tabancası

(23 sayfa)

6



- Dekupajlar
- Tilki kuyruğu

(24 sayfa)

7



Elektrikli Performansı AKÜ RAHATLIĞI!

1.000 Watt üzerinde **GÜÇ** Sunar



Mevcut 18V – 5.0 Ah akülü makineler 500W civarında güç üretebilirken, MultiVolt 36 Volt makinelerle eşleştirilen MultiVolt Lityum-iyon aküler, 1.000W üzerinde benzersiz kablosuz güç sunar.



UC18YSL3WHZ 18 V Makinelere takıldığında cihaza uyum sağlar ve 5.0 Ah kapasitede çalışır.



2 Adet BSL36A18X (Batarya)
+
1 Adet UC18YSL3 (Şarj Cihazı)



460 \$

UC18YSL3WJZ 18 V Makinelere takıldığında cihaza uyum sağlar ve 8.0 Ah kapasitede çalışır.



2 Adet BSL36B18X (Batarya)
+
1 Adet UC18YSL3 (Şarj Cihazı)



550 \$

UC18YTSL 14.4 V - 18 V 4'lü Batarya Şarj Cihazı



MODEL	VOLTAJ (Volt)	ŞARJ TİPİ	VERSİYON
UC18YTSL	14.4 - 18V	Li-ion	Slide Tip

- * Aynı anda 4 adet farklı kapasitede batarya şarj etme imkanı
- * 2 x USB giriş ile akıllı telefon şarj edebilme imkanı
- * Prize bağlı iken uzatma kablosu olarak kullanılabilir
- * Tutma sapı ile rahat taşıma imkanı.
- * 36 V bataryalar ile uyumludur.

280 \$

MultiVolt BATARYALAR



MODEL	AKÜ TİPİ	VERSİYON	VOLTAJ (Volt)	AKÜ KAPASİTESİ (Ah)	FİYAT (USD)
BSL36A18X	Li-ion	Slide Tip	36-18	2.5 - 5.0	210,00 \$
BSL36B18X	Li-ion	Slide Tip	36-18	4.0 - 8.0	250,00 \$

UC18YSL3 ŞARJ MAKİNASI



MODEL	VOLTAJ	ŞARJ TİPİ	VERSİYON	FİYAT (USD)
UC18YSL3*	14.4 - 18V	Li-ion	Slide Tip	100,00 \$

(* MultiVolt serisi aküler için UC 18YSL3 şarj cihazı kullanılmalıdır.)

AKÜLÜ DARBELİ MATKAP VİDALAMA / AKÜLÜ DARBELİ KIRICI - DELİCİLER

DV36DC 36 V / 155-100 Nm Akülü Darbeli Matkap Vidalama



- MULTI-VOLT akü teknolojisi: AC Güç, DC Özgürlük
- Duvarda delme için darbeleri delme fonksiyonu
- Sabit hız kontrolü, motorun yük altında bile hızını korumasını sağlamak için ekstra güç sağlar.
- Reaktif Kuvvet Kontrolü (RFC), makine çalışma sırasında aniden aşırı yüklenme yaşarsa motoru durdurur
- 32 dakika şarj süresi ve USB çıkışı ile hızlı şarj cihazı
- Yan tutamak, 11 farklı konumda ayarlanabilir.

MODEL	DV 36DA	
Akü voltajı	36 V	
	Hafif Çelik	20 mm
	Yumuşak Ahşap	118 mm
Kapasite	Tuğla	22 mm
	Ahşap Vidası	16x100 mm
	Makina Vidası	6 mm
Tork	Sert	155 Nm
	Yumuşak	100 Nm
Devir Hızı	Yüksek	0 - 2200 dev/dk
	Düşük	0 - 550 dev/dk
Darbe sayısı	Yüksek	0 - 33000 dar/dk
Akü süz Ağırlık	2.1 kg	



YENİ

Tek Makina (çanta içinde)	2.5 Ah 2 x BSL36A18X (Batarya) 1 x UC18YSL3 (Şarj Cihazı)	4.0 Ah 2 x BSL36B18X (Batarya) 1 x UC18YSL3 (Şarj Cihazı)
430 \$	860 \$	950 \$

Standart aksesuarlar
1 tutamak, 1 çanta



WH36DC 36 V / 215 Nm Akülü Darbeli Vidalama



- MULTI-VOLT akü teknolojisi: AC Güç, DC Özgürlük
- Güçlü ve hızlı iş için 215 Nm sabit tork
- Kompakt ve hafif: optimum manevra kabiliyeti için sadece 114 mm ve 1,6 kg
- Çok çeşitli vidalar ve malzemeler için 5 fonksiyon: yumuşak, güç, otomatik durdurma, cıvata ve kendinden kılavuzlu vidalar
- Cıvata veya somunların hızlı ve verimli bir şekilde sıkılması veya gevşetilmesi için cıvata modu
- En zorlu hava koşulları ve yüksek toz direnci için toz ve su girişine karşı üstün koruma sağlayan IP56

MODEL	WH 36DC	
Akü voltajı	36 V	
	Sıradan Cıvata	5 - 18 mm
	Yüksek Mukavemetli Cıvata	5 - 14 mm
Kapasite	Makine Vidası	4 - 10 mm
	Akıllı Vida	3.5 - 6 mm
Uç Girişi	Altıgen	1/4" (6.35 mm)
Sıkma Torku	215 Nm	
	Yumuşak Mod	0 - 900 dev/dk
	Normal Mod	0 - 2900 dev/dk
	Güç Modu	0 - 3400 dev/dk
	Akıllı Vida Modu	0 - 2900 dev/dk
Devir Hızı	Yumuşak Mod	0 - 2000 dar/dk
	Normal Mod	0 - 4100 dar/dk
	Güç Modu	0 - 4100 dar/dk
	Akıllı Vida Modu	0 - 2200 dar/dk
Tam Yüklü Darbe Sayısı	0.9 kg	
Akü süz Ağırlık	0.9 kg	



Tek Makina (çanta içinde)	2.5 Ah 2 x BSL36A18X (Batarya) 1 x UC18YSL3 (Şarj Cihazı)	4.0 Ah 2 x BSL36B18X (Batarya) 1 x UC18YSL3 (Şarj Cihazı)
320 \$	750 \$	840 \$

Standart aksesuarlar
1 çanta



DH3628DA 36 V / 28 mm Akülü Kırıcı Delici



- MULTI-VOLT akü teknolojisi: AC Güç, DC Özgürlük
- Üç çalışma modu: delme, darbeleri delme ve kırma
- Kompakt, hafif ve ergonomik tasarım
- Sabit hız kontrolü, motorun yük altında bile hızını korumasını sağlamak için ekstra güç sağlar
- Reaktif Kuvvet Kontrolü (RFC), makine çalışma sırasında aniden aşırı yüklenme yaşarsa motoru durdurur.
- Çalışma yüzeyinin net bir şekilde görülebilmesi için entegre LED ışık

MODEL	DH 36DPA	
Akü voltajı	36 V	
	Beton	28 mm
Kapasite	Çelik	13 mm
	Ahşap	32 mm
Uç Tipi	SDS-plus	
Devir Hızı	0 - 950 dev/dk	
Tam Yüklü Darbe Sayısı	0 - 4300 dar/dk	
Darbe Kuvveti	3.2 Joule	
Akü süz Ağırlık	3.2 kg	



YENİ

Tek Makina (çanta içinde)	2.5 Ah 2 x BSL36A18X (Batarya) 1 x UC18YSL3 (Şarj Cihazı)	4.0 Ah 2 x BSL36B18X (Batarya) 1 x UC18YSL3 (Şarj Cihazı)
670 \$	1100 \$	1190 \$

Standart aksesuarlar
1 tutamak, 1 derinlik mastarı, 1 çanta



AKÜLÜ DARBELİ SOMUN SIKMALAR

WR36DE 36 V / 770 Nm / 1/2" Akülü Darbeli Somun Sıkma



- MULTI-VOLT akü teknolojisi: AC Güç, DC Özgürlük
- Zorlu uygulamalar için 770 Nm'ye varan yüksek sıkma torku ve 1.050 Nm'ye varan gevşetme torku
- En zorlu hava koşulları ve yüksek toz direnci için toz ve su girişine karşı üstün koruma sağlayan IP56
- Farklı uygulamalar için 4 hız ayarı ve 4 otomatik durdurma fonksiyonu
- Otomatik durdurma fonksiyonu, vidaların aşırı sıkılmasını önlemek için önceden ayarlanmış bir süreden sonra aleti durdurur

MODEL	WR 36DE	
Akü voltajı	36 V	
Kapasite	Cıvata	M10 - M24
	Yüksek Mukavemetli Cıvata	M10 - M20
Uç Girişi	Kare Soket	1/2" (12.7 mm)
Sıkma Torku	770 Nm	
Devir Hızı	Düşük Mod 1	0 - 1500 dev/dk
	Düşük Mod 2	0 - 1800 dev/dk
	Orta Mod	0 - 2100 dev/dk
	Yüksek Mod	0 - 2400 dev/dk
Darbe sayısı	Düşük Mod 1	0 - 2200 dar/dk
	Düşük Mod 2	0 - 2600 dar/dk
	Orta Mod	0 - 3000 dar/dk
	Yüksek Mod	0 - 3400 dar/dk
Aküsüz Ağırlık	1.9 kg	



Tek Makina (çanta içinde)	2.5 Ah 2 x BSL36A18X (Batarya) 1 x UC18YSL3 (Şarj Cihazı)	4.0 Ah 2 x BSL36B18X (Batarya) 1 x UC18YSL3 (Şarj Cihazı)
370 \$	800 \$	890 \$

Standart aksesuarlar
1 çanta



WR36DB 36 V / 1050 Nm / 1/2" Akülü Darbeli Somun Sıkma



- MULTI-VOLT akü teknolojisi: AC Güç, DC Özgürlük
- Zorlu uygulamalar için 1.050 Nm'ye varan güçlü sıkma torku ve 1.650 Nm'ye varan gevşetme torku
- En zorlu hava koşulları ve yüksek toz direnci için toz ve su girişine karşı üstün koruma sağlayan IP56
- Tork seçici, 4 farklı uygulama için doğru sıkma torkunu sağlar
- Entegre batarya tamponlama sistemi, batarya arayüzünün ve cihazın ömrünü uzatır
- Uzun hizmet ömrü için alüminyum burçlu son derece sağlam çekiç muhafazası

MODEL	WR 36DB	
Akü voltajı	36 V	
Kapasite	Cıvata	M12 - M30
	Yüksek Mukavemetli Cıvata	M10 - M24
Uç Girişi	Kare Soket	1/2" (12.7 mm)
Sıkma Torku	1050 Nm	
Devir Hızı	Düşük Mod 1	0 - 600 dev/dk
	Düşük Mod 2	0 - 900 dev/dk
	Orta Mod	0 - 1200 dev/dk
	Yüksek Mod	0 - 1500 dev/dk
Darbe sayısı	Düşük Mod 1	0 - 1200 dar/dk
	Düşük Mod 2	0 - 1800 dar/dk
	Orta Mod	0 - 2300 dar/dk
	Yüksek Mod	0 - 2800 dar/dk
Aküsüz Ağırlık	3.0 kg	



Tek Makina (çanta içinde)	2.5 Ah 2 x BSL36A18X (Batarya) 1 x UC18YSL3 (Şarj Cihazı)	4.0 Ah 2 x BSL36B18X (Batarya) 1 x UC18YSL3 (Şarj Cihazı)
550 \$	980 \$	1070 \$

Standart aksesuarlar
1 çanta



WR36DA 36 V / 1100 Nm / 3/4" Akülü Darbeli Somun Sıkma



- MULTI-VOLT akü teknolojisi: AC Güç, DC Özgürlük
- Zorlu uygulamalar için 1.1100 Nm'ye varan güçlü sıkma torku ve 1.800 Nm'ye varan gevşetme torku
- En zorlu hava koşulları ve yüksek toz direnci için toz ve su girişine karşı üstün koruma sağlayan IP56
- Tork seçici, 4 farklı uygulama için doğru sıkma torkunu sağlar
- Entegre batarya tamponlama sistemi, batarya arayüzünün ve cihazın ömrünü uzatır
- Uzun hizmet ömrü için alüminyum burçlu son derece sağlam çekiç muhafazası

MODEL	WR 36DA	
Akü voltajı	36 V	
Kapasite	Cıvata	M12 - M30
	Yüksek Mukavemetli Cıvata	M10 - M24
Uç Girişi	Kare Soket	3/4" (19 mm)
Sıkma Torku	1100 Nm	
Devir Hızı	Düşük Mod 1	0 - 600 dev/dk
	Düşük Mod 2	0 - 900 dev/dk
	Orta Mod	0 - 1200 dev/dk
	Yüksek Mod	0 - 1500 dev/dk
Darbe sayısı	Düşük Mod 1	0 - 1200 dar/dk
	Düşük Mod 2	0 - 1800 dar/dk
	Orta Mod	0 - 2300 dar/dk
	Yüksek Mod	0 - 2900 dar/dk
Aküsüz Ağırlık	3.0 kg	



Tek Makina (çanta içinde)	2.5 Ah 2 x BSL36A18X (Batarya) 1 x UC18YSL3 (Şarj Cihazı)	4.0 Ah 2 x BSL36B18X (Batarya) 1 x UC18YSL3 (Şarj Cihazı)
560 \$	990 \$	1080 \$

Standart aksesuarlar
1 çanta



AKÜLÜ TAŞLAMA / AKÜLÜ DAİRE TESTERE / AKÜLÜ TILKI KUYRUĞU TESTERE

G3612DA - G3613DA 36 V / 115 mm-125 mm Akülü Taşlamalar



- MULTI-VOLT akü teknolojisi: AC Güç, DC Özgürlük
- Kompakt gövde ve küçük kavrama çevresi
- Farklı uygulamalar ve malzemeler için değişken hız ayarı
- Büyük iki kademeli paletli anahtar sayesinde gelişmiş kullanıcı güvenliği
- Gelişmiş kontrol için yumuşak başlangıç
- Yeniden başlatma önleyici koruma, istem dışı yeniden başlatma nedeniyle kazaları önler
- Geri tepme koruma sistemi, dönüş hızı düşerse motoru durdurur

MODEL	G 3612DA - G 3613DA	
Akü voltajı	36 V	
Disk	Dış Çap	115mm - 125 mm
	İç Çap	22.23 mm
İş Mili	M14 x 2	
Devir Hızı	Vites Modu	3000 - 9500 dev/dk
	Otomatik Mod	5500 dev/dk
Akü süz Ağırlık	2.1 kg	



Tek Makina (çanta içinde)	2.5 Ah 2 x BSL36A18X (Batarya) 1 x UC18YSL3 (Şarj Cihazı)	4.0 Ah 2 x BSL36B18X (Batarya) 1 x UC18YSL3 (Şarj Cihazı)
420 \$	850 \$	940 \$

Standart aksesuarlar
1 tutamak, 1 anahtar, 1 çanta



C3607DA 36 V / 185 mm Akülü Daire Testere



- MULTI-VOLT akü teknolojisi: AC Güç, DC Özgürlük
- Yüksek kesme hızı ve kesme derinliği – 66mm
- Sessiz mod gürültüyü azaltır ve motor verimliliğini artırır
- Gelişmiş kontrol için yumuşak başlangıç ve hızlı durdurma freni
- Kesme sırasında yüksek görünürlük için üfleyici fonksiyonu ve LED çalışma ışığı
- Pürüzsüz kesim için flor kaplı taban
- Kompakt ve hafif tasarım

MODEL	C 3607DA	
Akü voltajı	36 V	
Kapasite	Bıçak Çapı	185 mm
	Maks. Kesme Derinliği (90°)	62 mm
	Maks. Kesme Derinliği (45°)	47.5 mm
	Maks. Kesme Derinliği (55°)	39 mm
Devir hızı	Güç Modu	4300 dev/dk
	Sessiz Mod	2000 dev/dk
Akü süz Ağırlık	3.3 kg	



Tek Makina (çanta içinde)	2.5 Ah 2 x BSL36A18X (Batarya) 1 x UC18YSL3 (Şarj Cihazı)	4.0 Ah 2 x BSL36B18X (Batarya) 1 x UC18YSL3 (Şarj Cihazı)
420 \$	850 \$	940 \$

Standart aksesuarlar
1 bıçak, 1 anahtar, 1 toz toplama seti, 1 kılavuz, 1 çanta



CR36DA 36 V / 28 mm Akülü Tilki Kuyruğu Testere



- MULTI-VOLT akü teknolojisi: AC Güç, DC Özgürlük
- HiKOKI'nin etkili titreşim önleme sistemi (UVP) sayesinde çok düşük titreşimler.
- Benzersiz orbital kesme mekanizması – akülü aletlerde bir ilk
- Birçok uygulama için dört elektrikli strok hızı ayarı ve ek otomatik mod (AT modu)
- Yüksek kullanım kolaylığı için aletsiz testere bıçağı değişimi (PL sistemi)
- Uzun testere bıçaklarının güvenli yönlendirilmesi için aletsiz ayarlanabilir kılavuz pabuç

MODEL	CR36DA	
Akü Voltajı	36 V	
Kapasite	Yumuşak Çelik Boru	130 mm
	PVC Boru	130 mm
	Ahşap	300 mm
	Yumuşak Çelik Plaka	19 mm
Stroke Boyu	32 mm	
Yüksüz Hızı	0-3000 dev/dk	
Akü süz Ağırlık	3.9 kg	



Tek Makina (çanta içinde)	2.5 Ah 2 x BSL36A18X (Batarya) 1 x UC18YSL3 (Şarj Cihazı)	4.0 Ah 2 x BSL36B18X (Batarya) 1 x UC18YSL3 (Şarj Cihazı)
540 \$	970 \$	1060 \$

Standart aksesuarlar
1 çanta, 1 bıçak



AKÜLÜ DARBELİ - DARBESİZ VİDALAMA MATKAPLAR

DV12DA - 2.5 12 V / 38 Nm Akülü Darbeli Vidalama Matkap



- Sınıfındaki en yüksek tork – 38Nm
- Optimum kullanım için 2 vitesli şanzımana sahip kompakt ve hafif akülü darbeli matkap
- Rahat kullanım ve güvenli tutuş için ergonomik tasarım ve kauçuk yüzey
- Duvarda delme için mekanik darbeli delme fonksiyonu
- Kolay ve güvenli uç ve matkap değişimi için 10 mm tek kovanlı anahtarsız mandren
- Çalışma alanının iyi aydınlatılması için entegre LED



18v

MODEL	DV 12DA	
Akü voltajı	12 V	
Delme çapı	Çelik	10 mm
	Ahşap	29 mm
	Tuğla	8 mm
Sıkma Torku	15 / 38 Nm	
Darbe Oranı	0-5250/ 0-21000 dar/dk	
Devir	0-350/ 0-1400 dev/dk	
Ağırlık	1.2 kg	

LI-ION BATTERY

2.5 Ah

2 x 2.5 Ah
(Batarya)
1 x UC18YFSL
(Şarj Cihazı)

230 \$



Standart aksesuarlar

1 çanta, 2 akü, 1 şarj makinesi

DS18DA 18 V / 50 Nm Akülü Darbesiz Vidalama Matkap



- Optimum kullanım için 2 vitesli şanzımana sahip kompakt ve hafif akülü matkap
- Geniş bir uygulama yelpazesi için 20 kademeli tork ayarı
- Kolay ve güvenli uç veya matkap değişimi için 13 mm tek kovanlı anahtarsız mandren
- Rahat kullanım ve güvenli tutuş için ergonomik tasarım ve kauçuk yüzey
- Çalışma alanının iyi aydınlatılması için entegre LED



18v

MODEL	DS 18DA	
Akü voltajı	18 V	
Delme çapı	Çelik	13 mm
	Ahşap	36 mm
	Tuğla	13 mm
Sıkma Torku	18 / 50 Nm	
Devir	0-350 / 0-1400 dev/dk	
Akü süz Ağırlık	0.9 kg	

LI-ION BATTERY

2.0 Ah

2 x 2.0 Ah
(Batarya)
1 x UC18YFSL
(Şarj Cihazı)

(çanta içinde)

210 \$

5.0 Ah

2 x 5.0 Ah
(Batarya)
1 x UC18YFSL
(Şarj Cihazı)

(çanta içinde)

350 \$



DV18DA 18 V / 50 Nm Akülü Darbeli Vidalama Matkap



- Optimum kullanım için 2 vitesli şanzımana sahip kompakt ve hafif akülü darbeli matkap
- Duvarda delme için mekanik darbeli delme fonksiyonu
- Geniş bir uygulama yelpazesi için 20 kademeli tork ayarı
- Geniş bir aksesuar yelpazesi için 13 mm anahtarsız mandren
- Rahat kullanım ve güvenli tutuş için ergonomik tasarım ve kauçuk yüzey
- Çalışma alanının iyi aydınlatılması için entegre LED



18v

MODEL	DV 18DA	
Akü voltajı	18 V	
Delme çapı	Çelik	13 mm
	Ahşap	36 mm
	Tuğla	13 mm
Sıkma Torku	18 / 50 Nm	
Darbe Oranı	0-5250/ 0-21000 dar/dk	
Devir	0-350/ 0-1400 dev/dk	
Akü süz Ağırlık	1.0 kg	

LI-ION BATTERY

2.0 Ah

2 x 2.0 Ah
(Batarya)
1 x UC18YFSL
(Şarj Cihazı)

(çanta içinde)

210 \$

5.0 Ah

2 x 5.0 Ah
(Batarya)
1 x UC18YFSL
(Şarj Cihazı)

(çanta içinde)

350 \$



AKÜLÜ DARBELİ VİDALAMA MATKAPLAR / AKÜLÜ DARBELİ VİDALAMA

DV18DD 18 V / 55 Nm Akülü Darbeli Vidalama Matkap



- Maksimum 55Nm sıkma torkuna sahip güçlü kömürsüz motor
- 2 vitesli şanzımana sahip kompakt ve hafif akülü darbeli matkap
- Elektrik freni
- Optimum kontrol ve daha uzun süre konforlu çalışma için ergonomik yumuşak dokunuşlu sap
- Geniş bir uygulama yelpazesi için 20 kademe tork ayarı
- Çalışma alanının iyi aydınlatılması için entegre LED



18v

MODEL	DV 18DD	
Akü voltajı	18 V	
Delme çapı	Çelik	13 mm
	Ahşap	36 mm
	Tuğla	13 mm
Sıkma Torku	26 / 55 Nm	
Darbe Oranı	0-6600/ 0-25500 dar/dk	
Devir	0-440/ 0-1700 dev/dk	
Aküslük Ağırlık	0.75 kg	

LI-ION BATTERY

BRUSH LESS MOTOR

Tek Makina (karton kutu)	2.0 Ah 2 x 2.0 Ah (Batarya) 1 x UC18YFSL (Şarj Cihazı)	5.0 Ah 2 x 5.0 Ah (Batarya) 1 x UC18YFSL (Şarj Cihazı)
140 \$	320 \$	460 \$



DV18DE 18 V / 70 Nm Akülü Darbeli Vidalama Matkap



- Toplam uzunluk sadece 159 mm. Maksimum manevra kabiliyeti ve kullanım kolaylığı
- Zorlu uygulamaları hızla tamamlamak için yüksek tork ve yüksek hız
- Yüksek performans, daha az aşınma ve yıpranma ve daha fazla dayanıklılık için kömürsüz motor
- Reaktif Kuvvet Kontrolü (RFC), çalışma sırasında makine aniden aşırı yüklenirse motoru durdurur
- Farklı uygulamalar için 22 tork ayarı



18v

MODEL	DV 18DE	
Akü voltajı	18 V	
Delme çapı	Çelik	13 mm
	Ahşap	52 mm
	Tuğla	13 mm
Sıkma Torku	40 / 70 Nm	
Darbe Oranı	0-30000 dar/dk	
Devir	0-550/ 0-2000 dev/dk	
Aküslük Ağırlık	1.2 kg	

LI-ION BATTERY

BRUSH LESS MOTOR

RFC REACTIVE FORCE CONTROL

Tek Makina (karton kutu)	2.0 Ah 2 x 2.0 Ah (Batarya) 1 x UC18YFSL (Şarj Cihazı)	5.0 Ah 2 x 5.0 Ah (Batarya) 1 x UC18YFSL (Şarj Cihazı)
250 \$	430 \$	570 \$



WH18DA 18 V / 140 Nm Akülü Darbeli Vidalama



- M14 boyutuna kadar metrik vidaların sabitlenmesi için güçlü tork
- Kompakt ve hafif gövde sayesinde dar alanlarda rahat kullanım
- Çalışma alanının iyi aydınlatılması için entegre LED



18v

MODEL	WH 18DA	
Akü voltajı	18 V	
Kapasite	Sıradan Cıvata	M5-M14
	Yüksek Mukavemetli Cıvata	M5-M12
	Makine Vidası	4 - 8 mm
Devir Hızı	0-2700 dev/dk	
Darba Sayısı	0-3600 dar/dk	
Sıkma Torku	140 Nm	
Aküslük Ağırlık	0.9 kg	

LI-ION BATTERY

Tek Makina (karton kutu)	2.0 Ah 2 x 2.0 Ah (Batarya) 1 x UC18YFSL (Şarj Cihazı)	5.0 Ah 2 x 5.0 Ah (Batarya) 1 x UC18YFSL (Şarj Cihazı)
140 \$	320 \$	460 \$



AKÜLÜ DARBELİ VİDALAMA - AKÜLÜ DARBELİ SOMUN SIKMA

WH18DC 18 V / 210 Nm Akülü Darbeli Vidalama



- Güçlü ve hızlı: En zorlu işler için 210 Nm'lik sabit tork
- Kompakt ve Hafif: Dar alanlarda gün boyu zahmetsizce çalışmak için sadece 114 mm ve 1,6 kg ağırlık
- Hassas tetik anahtarı, hassas vidaların aşırı sıkılmaması için aleti 100 rpm'de başlatır
- Çok çeşitli vidalar ve malzemeler için 5 fonksiyon: yumuşak, güç, otomatik durdurma, civata ve kendinden kılavuzlu vidalar



18v

MODEL	WH 18DC	
Akü voltajı	18 V	
Kapasite	Sıradan Civata	5 - 18 mm
	Yüksek Mukavemetli Civata	5 - 14 mm
	Küçük Vida	4 - 10 mm
	Akıllı Vida	3.5 - 6 mm
Uç Girişi	Altıgen	1/4" (6.35 mm)
	Sıkma Torku	210 Nm
Devir Hızı	Yumuşak Mod	0 - 900 dev/dk
	Normal Mod	0 - 2900 dev/dk
	Güç Modu	0 - 3400 dev/dk
	Akıllı Vida Modu	0 - 2900 dev/dk
Tam Yüklü Darbe Sayısı	Yumuşak Mod	0 - 1900 dar/dk
	Normal Mod	0 - 4000 dar/dk
	Güç Modu	0 - 4000 dar/dk
Akü süz Ağırlık	0 - 2100 dar/dk 0.9 kg	

IP56

LI-ION BATTERY

BRUSHLESS MOTOR



Tek Makina (karton kutu)	2.0 Ah (Batarya) 1 x UC18YFSL (Şarj Cihazı)	5.0 Ah (Batarya) 1 x UC18YFSL (Şarj Cihazı)
280 \$	460 \$	600 \$

WR18DF 18 V / 220 Nm Akülü Darbeli Somun Sıkma



- 220Nm yüksek tork ile güvenilir performans
- Kompakt ve hafif gövde sayesinde dar alanlarda rahat kullanım
- Çalışma alanının iyi aydınlatılması için entegre LED



18v

MODEL	WR 18DF	
Akü voltajı	18 V	
Sıkma kapasitesi	Std. civata	M10 - M16
	Sert civata	M8 - M14
Sıkma torku	220 Nm	
Devir Hızı	0-2400 dev/dk	
Darbe sayısı	0-3200 dar/dk	
Uç girişi	1/2" kare soket	
Akü süz Ağırlık	1.0 kg	

LI-ION BATTERY



Tek Makina (karton kutu)	2.0 Ah (Batarya) 1 x UC18YFSL (Şarj Cihazı)	5.0 Ah (Batarya) 1 x UC18YFSL (Şarj Cihazı)
160 \$	340 \$	480 \$

WR18DH 18 V / 345 Nm Akülü Darbeli Somun Sıkma



- Sınıfının en güçlüsü ve hızlısı; 345 Nm.
- Kompakt ve hafif: 144 mm ve 2.0 kg ağırlık
- Civataların aşırı sıkılmasını önlemek için Auto-Stop fonksiyonu
- Sökülen civataların düşmesini engelleyen Auto-Slow fonksiyonu
- Motor ısı üretimini düşük tutan HİKOKI teknolojisi ile rakip ürünlere göre daha fazla ve sürekli çalışma
- Kolayca soket takma-çıkarma



18v

MODEL	WR 18DH	
Akü voltajı	18 V	
Sıkma kapasitesi	Std. civata	M10 - M20
	Sert civata	M10 - M16
Sıkma torku	345 Nm	
Devir hızı	Düşük Mod	0-1200dev/dk
	Orta Mod	0-2400 dev/dk
	Tekli Mod	0-1800 dev/dk
Darbe sayısı	Yük Modu	0-2800 dev/dk
	Uç girişi	1/2" kare soket
Akü süz Ağırlık	1.3 kg	

IP56

LI-ION BATTERY

BRUSHLESS MOTOR



Tek Makina (karton kutu)	2.0 Ah (Batarya) 1 x UC18YFSL (Şarj Cihazı)	5.0 Ah (Batarya) 1 x UC18YFSL (Şarj Cihazı)
290 \$	470 \$	610 \$

AKÜLÜ AVUÇ TAŞLAMALAR / AKÜLÜ KALIPÇI TAŞLAMA

G18DSL2 115 mm / 18 V Akülü Avuç Taşlama



- Optimize edilmiş dişli oranı ve daha büyük motor fanı sayesinde geliştirilmiş aşırı yük dayanıklılığı
- Küçük kavrama çapına sahip hafif ve kompakt gövde
- Güvenli kullanım ve uzun hizmet ömrü için kompakt ve sağlam
- Maksimum güvenlik için yeniden başlatma koruması



18v

MODEL	G 18DSL2
Akü voltajı	18 V
Disk çapı	115 mm
Mil vidası	M14 x 2
Devir hızı	9000 dev/dk
Akü süz Ağırlık	1.5 kg

LI-ION BATTERY



Tek Makina (karton kutu)	2.0 Ah 2 x 2.0 Ah (Batarya) 1 x UC18YFSL (Şarj Cihazı) (çanta içinde)	5.0 Ah 2 x 5.0 Ah (Batarya) 1 x UC18YFSL (Şarj Cihazı) (çanta içinde)
170 \$	350 \$	490 \$

G1813DA 125 mm / 18 V Akülü Avuç Taşlama



- Yüksek güç çıkışı, 750 şebeke elektriğiyle çalışan bir avuç taşlama makinesiyle karşılaştırılabilir
- HiKOKI teknolojisi ile geri tepme durdurma koruması ve yumuşak başlatma fonksiyonu sayesinde yüksek koruma
- Sabit hız kontrolü
- Maksimum güvenlik için yeniden başlatma koruması
- Güvenli ve rahat kullanım için titreşim önleyici yan tutamak
- Yeni, yıkanabilir ve değiştirilebilir polyester havalandırma ızgaraları sayesinde suya ve toza dayanıklı



18v

MODEL	G18 13DA
Akü voltajı	18 V
Disk çapı	125 mm
Mil vidası	M10 x 1.25
Devir hızı	8000 dev/dk
Akü süz Ağırlık	2.1 kg

BRUSH LESS MOTOR

LI-ION BATTERY



Tek Makina (karton kutu)	2.0 Ah 2 x 2.0 Ah (Batarya) 1 x UC18YFSL (Şarj Cihazı) (çanta içinde)	5.0 Ah 2 x 5.0 Ah (Batarya) 1 x UC18YFSL (Şarj Cihazı) (çanta içinde)
280 \$	460 \$	600 \$

GP18DA 18 V / 6 mm Akülü Kalıpçı Taşlama



- Yüksek performans, daha az aşınma ve yıpranma ve daha fazla dayanıklılık için fırçasız motor
- Malzemeye özel taşlama için 5 kademeli hız kontrolü, ayrıca rölanti ve yük arasında optimum kontrol için otomatik mod
- Yüke bağlı olarak, hızı otomatik olarak kontrol etmek için otomatik mod
- Güvenlik için geri tepme koruması ve daha uzun hizmet ömrü için aşırı yük koruması
- En dar alanlarda çalışma için ergonomik ve ince tasarım



18v

MODEL	GP 18DA
Akü voltajı	18 V
Max. taş çapı	50 mm
Pens	6 mm
Devir sayısı	7000 - 29000 dev/dk
Uzunluk	464 mm*
Ağırlık	1.65 kg

LI-ION BATTERY

BRUSH LESS MOTOR



Tek Makina (karton kutu)	2.0 Ah 2 x 2.0 Ah (Batarya) 1 x UC18YFSL (Şarj Cihazı) (çanta içinde)	5.0 Ah 2 x 5.0 Ah (Batarya) 1 x UC18YFSL (Şarj Cihazı) (çanta içinde)
360 \$	540 \$	680 \$

*BSL1850C batarya ile

AKÜLÜ KIRICI DELİCİLER / AKÜLÜ DAİRE TESTERE

DH18DPC 18 V / 3.2 J Akülü Kırıcı Delici



- Kompakt ve hafif kırıcı delici, 3.2 joule darbe kuvveti.
- Kömürsüz motor sayesinde yüksek performans, daha az aşınma ve daha fazla dayanıklılık
- Kayma olmadan rahat delme için yumuşak başlatma kontrolörü
- Otomatik Durdurma Fonksiyonu: Aynı derinlikte birden fazla deliğin kolay ve sürekli bir şekilde delinmesi için delme süresini kaydeder ve saklar

18v

MODEL	DH 18DPC	
Akü voltajı	18 V	
	Beton	26 mm
Delme Kapasitesi	Çelik	13 mm
	Ahşap	27 mm
Uç tipi	SDS-plus	
Devir hızı	0-700 / 0-950 dev/dk	
Tam yüklü darbe sayısı	0-3170 / 0-4300 dar/dk	
Darbe Kuvveti	3.2 J	
Aküslük Ağırlık	2.8 kg	



Tek Makina (karton kutu)	2.0 Ah 2 x 2.0 Ah (Batarya) 1 x UC18YFSL (Şarj Cihazı) (çanta içinde)	5.0 Ah 2 x 5.0 Ah (Batarya) 1 x UC18YFSL (Şarj Cihazı) (çanta içinde)
390 \$	570 \$	710 \$

Standart aksesuarlar
1 derinlik mastarı, 1 tutamak

DH1826DA 18 V / 3.2 J Akülü Kırıcı Delici



- Üç çalışma modu: delme, darbeli delme veya kırma
- Darbe enerjisi 3,2 Joule. Betonda 26 mm delme kapasitesi
- Yüksek performans, daha az aşınma ve daha uzun ömür için kömürsüz motor
- Reaktif Kuvvet Kontrolü (RFC), çalışma sırasında makine aniden aşırı yüklenirse motoru durdurur
- Otomatik durdurma fonksiyonu

18v

MODEL	DH 18DPC	
Akü voltajı	18 V	
	Beton	26 mm
Delme Kapasitesi	Çelik	13 mm
	Ahşap	27 mm
Uç tipi	SDS-plus	
Devir hızı	0-700 / 0-950 dev/dk	
Tam yüklü darbe sayısı	0-3170 / 0-4300 dar/dk	
Darbe Kuvveti	3.2 J	
Aküslük Ağırlık	3.1 kg	



Tek Makina (karton kutu)	2.0 Ah 2 x 2.0 Ah (Batarya) 1 x UC18YFSL (Şarj Cihazı) (çanta içinde)	5.0 Ah 2 x 5.0 Ah (Batarya) 1 x UC18YFSL (Şarj Cihazı) (çanta içinde)
530 \$	710 \$	850 \$

C1807DA 18 V / 190 mm Akülü Daire Testere



- Farklı çalışma alanlarında mükemmel kesme performansı sergileyerek, kalın ahşapları bile rahatça kesebilme
- Konforlu kullanımıyla, yüksek hassasiyetli kesim
- Rahat kullanımı ve güvenli tutuş ile ergonomik tasarım
- Kesme sırasında yüksek görünürlük için entegre LED çalışma ışığı
- Kullanıcı güvenliği için hızlı durdurma freni

MODEL	C1807DA	
Akü voltajı	18 V	
	Bıçak Çapı	190 mm
Kapasite	Maks. Kesme Derinliği (90°)	64.5 mm
	Maks. Kesme Derinliği (45°)	49 mm
	Maks. Kesme Derinliği (55°)	39 mm
Devir hızı	Güç Modu	3800 dev/dk
	Sessiz Mod	2000 dev/dk
Aküslük Ağırlık	3.5 kg	



Tek Makina (karton kutu)	2.0 Ah 2 x 2.0 Ah (Batarya) 1 x UC18YFSL (Şarj Cihazı) (çanta içinde)	5.0 Ah 2 x 5.0 Ah (Batarya) 1 x UC18YFSL (Şarj Cihazı) (çanta içinde)
390 \$	570 \$	710 \$

UC18YFSLWFZ



2 Adet 18V 2.0 Ah
BSL1820M (Batarya)

LI-ION
BATTERY

+
1 Adet
UC18YFSL (Şarj Cihazı)

210 \$

UC18YSL3WGZ



2 Adet 18V 5.0 Ah
BSL1850 (Batarya)

LI-ION
BATTERY

+
1 Adet
UC18YSL3 (Şarj Cihazı)

350 \$

BATARYALAR

	KOD NO	MODEL	AKÜ TİPİ	VERSİYON	VOLTAJ (Volt)	AKÜ KAPASİTESİ (Ah)	FİYAT (USD)
	329371	BCL1015	Li-ion	Kaset Tip	10.8	1.5	65,00 \$
	377796	BSL1820M	Li-ion	Slide Tip	18	2.0	80,00 \$
	335790	BSL1850	Li-ion	Slide Tip	18	5.0	160,00 \$

ŞARJ MAKİNELERİ

	KOD NO	MODEL	VOLTAJ (Volt)	ŞARJ TİPİ	VERSİYON	ŞARJ SÜRESİ (Dakika)	FİYAT (USD)
	UC10SL2	UC10SL2	10,8	Li-ion	Kaset Tip	40	60,00 \$
	UC18YFSL	UC18YFSL	14.4 - 18	Li-ion	Slide Tip	60	70,00 \$

DARBESİZ MATKAPLAR / DARBELİ MATKAPLAR

D10VC3 10 mm / 600 W Darbesiz Matkap



- Güçlü motor 600 W
- Düşük titreşim ve sessiz çalışma
- 10 mm anahtarsız mandren
- Ergonomik tasarım
- Güvenli ve rahat tutuş için yumuşak sap
- Devir sayısı ön seçimi
- Sağ-sol dönüş



MODEL	D 10VC3
Mandren kapasitesi	1-10 mm
Çelikte delme çapı	10 mm
Ahşapta delme çapı	25 mm
Güç	600 W
Devir sayısı	0-2500 dev/dk
Uzunluk	242 mm
Ağırlık	1.4 kg
Koli Adedi	5



115 \$

D13VL 13mm / 860 W Darbesiz Matkap



- 860 W'lık güçlü Hikoki Motoru
- Sağlam alüminyum gövde (AHB)
- "Slip Clutch" teknolojisi ile aşırı yüklenmelerde dişli sıyırmasına son
- Ergonomik yan tutamak ve kabza
- Anahtarsız mandren



MODEL	D 13VL
Mandren kapasitesi	1.5-13 mm
Çelikte delme çapı	13 mm (düşük hız) 8 mm (yüksek hız)
Ahşapta delme çapı	40 mm (düşük hız) 25 mm (yüksek hız)
Güç	860 W
Devir sayısı	0-1100/3000 dev/dk
Ağırlık	2.9 kg
Koli Adedi	6



320 \$

Standart aksesuarlar:

1 tutamak, 1 derinlik mastarı

DV13VST 13 mm / 550 W Darbeli Matkap



- 550 W güçlü motor
- 13 mm mandren kapasitesi
- Kullanımı rahat büyük tetik
- Sağ-sol dönüş
- Elektronik hız kontrolü
- Yumuşak tutma sapı
- Hem tetikten hem de devir ayar düğmesinden hız değiştirme

MODEL	DV 13VST
Mandren kapasitesi	1.5-13 mm
Çelikte delme çapı	13 mm
Ahşapta delme çapı	25 mm
Güç	550 W
Devir sayısı	0-3000/dk
Darbe oranı	0-48000 dar/dk
Uzunluk	295 mm
Ağırlık	1.8 kg
Koli Adedi	6



70 \$

Standart aksesuarlar:

1 mandren anahtarı, 1 tutamak, derinlik mastarı

DARBELİ MATKAPLAR

DV18V 13 mm / 690 W Darbeli Matkap



- 690 W güçlü Hikoki motoru
- 13 mm anahtarlı mandren
- 2 vitesli şanzıman
- Hafif ve kompakt yapı
- Devir sayısı ön seçimi
- Sağ-sol dönüş
- Güvenli ve rahat tutuş için yumuşak sap

MODEL	DV 18V
Mandren kapasitesi	1.5-13 mm
Betonda delme çapı	18/13 mm
Çelikte delme çapı	13/8 mm
Ahşapta delme çapı	40/25 mm
Güç	690 W
Devir sayısı	0-1000/3000 dev/dk
Uzunluk	333 mm
Ağırlık	2 kg
Koli Adedi	3



Standart aksesuarlar:

1 çanta, 1 tutamak, 1 derinlik mastarı, 1 mandren anahtarı

210 \$

DV22V 13 mm / 1120 W Darbeli Matkap



- 1120 W'lık güçlü Hikoki Motoru
- Sağlam alüminyum gövde (AHB)
- "Slip Clutch" teknolojisi ile aşırı yüklenmelerde dişli sıyırmasına son
- Ergonomik yan tutamak ve kabza
- Yumuşak tutma sapı ve yan tutamak

MODEL	DV22V
Mandren kapasitesi	1.5-13 mm
Betonda delme çapı	22/13 mm
Çelikte delme çapı	16/8 mm
Ahşapta delme çapı	40/25 mm
Güç	1120 W
Devir sayısı	0-1100/3000 dev/dk
Darbe Sayısı	0-8100/0-22000 dar/dk
Ağırlık	3 kg
Koli Adedi	2



Standart aksesuarlar:

1 çanta, 1 tutamak, 1 derinlik mastarı

400 \$

DARBELİ SOMUN SIKMALAR

WR22SE 620 Nm / 800 W Darbeli Somun Sıkma



- Kömürsüz motorlu yenilikçi teknoloji
- Kendi sınıfının en küçük ve en hafifi
- Sağlam ve uzun ömürlü alüminyum gövde
- Kömürsüz motoru sayesinde voltaj düşüşlerinde dahi performansını korur
- Jeneratör ile çalışmaya uygun
- Ön ve arka tamponlar gövdeyi darbeleri karşı korur.
- Yumuşak ve ergonomik tutamak

Ürün Kodu	O-ring Çapı	Pim Uzunluğu	Fiyatı
751948	36 mm	35 mm	4,00 \$

* Detaylı bilgi için Sayfa 61'e bakınız.

Standart aksesuarlar:
1 tutamak, 1 adet çanta

MODEL	WR 22SE
Kapasite	M14-M24
Soket	19 mm (3/4")
Sıkma Torku	620 Nm
Güç	800 W
Darbe Sayısı	2000 dar/dk
Devir Sayısı	1400 dev/dk
Ağırlık	4.6 kg
Koli Adedi	1



1050 \$

WR25SE 1000 Nm / 900 W Darbeli Somun Sıkma



- Kömürsüz motorlu yenilikçi teknoloji
- Kendi sınıfının en ergonomiği
- Sağlam ve uzun ömürlü alüminyum gövde
- Kömürsüz motoru sayesinde voltaj düşüşlerinde dahi performansını korur
- Jeneratör ile çalışmaya uygun
- Ön ve arka tamponlar gövdeyi darbelerle karşı korur
- Yumuşak ve ergonomik tutamak

Ürün Kodu	O-ring Çapı	Pim Uzunluğu	Fiyatı
751474	43 mm	43 mm	9,00 \$
751475	46 mm	46 mm	10,00 \$

* Detaylı bilgi için Sayfa 37'e bakınız.

Standart aksesuarlar:
1 tutamak, 1 adet çanta

MODEL	WR 25SE
Kapasite	M22-M30
Soket	25,4 mm (1")
Sıkma Torku	1000 Nm
Güç	900 W
Darbe Sayısı	1500 dar/dk
Devir Sayısı	1100 dev/dk
Ağırlık	7.7 kg
Koli Adedi	1



1500 \$



AVUÇ TAŞLAMALAR

G12SR4 115 mm / 730 W Avuç Taşlama



- 730 W'lık sağlam Hikoki motoru
- Motorun daha verimli ve uzun ömürlü çalışması için yeni tasarlanmış geniş fan ve optimize edilmiş hava akışı
- Tek elle daha iyi kavranabilmek için ince gövde çapı
- Yandan kontrol edilen açma kapama düğmesi
- Güvenlikli tetik sayesinde makine fişe takılıyken enerji kesilmesi ve tekrar gelmesi durumunda motor doğrudan çalışmayarak olası iş kazalarının önüne geçilmiş olur.

MODEL G 12SR4

Güç	730 W
Disk çapı	115 mm
Mil vidası	M14x2
Devir sayısı	10000 dev/dk
Ağırlık	1.8 kg
Koli Adedi	6



80 \$

Standart aksesuarlar:

1 anahtar, 1 siperlik, 1 yan tutamak

G12SN2 115 mm / 900 W Avuç Taşlama



- Güçlü 900 W motor
- Kısa devreye karşı geliştirilmiş toza karşı koruma
- Aşınmaya dayanıklı armatür bobini
- Güvenlikli tetik sayesinde makine fişe takılıyken enerji kesilmesi ve tekrar gelmesi durumunda motor doğrudan çalışmayarak olası iş kazalarının önüne geçilmiş olur.

MODEL G 12SN2

Güç	900 W
Disk çapı	115 mm
Mil vidası	M14x2
Devir sayısı	10500 dev/dk
Ağırlık	2.0 kg
Koli Adedi	4



95 \$

Standart aksesuarlar:

1 anahtar, 1 siperlik, 1 yan tutamak

G12SE3 115 mm / 1400 W Avuç Taşlama



- Aşırı yüklenmeye karşı mükemmel dayanıklılık
- Anahtarsız siperlik değiştirme
- Kısa devreye karşı geliştirilmiş toza karşı koruma
- Aşınmaya dayanıklı armatür bobini
- Yumuşak başlangıç
- Güvenlikli tetik sayesinde makine fişe takılıyken enerji kesilmesi ve tekrar gelmesi durumunda motor doğrudan çalışmayarak olası iş kazalarının önüne geçilmiş olur.
- Alttan tetik

MODEL G 12SE3

Güç	1400 W
Disk çapı	115 mm
Mil vidası	M14x2
Devir sayısı	11500 dev/dk
Ağırlık	2.5 kg
Koli Adedi	4



220 \$

Standart aksesuarlar:

1 anahtar, 1 siperlik, 1 yan tutamak

G13SB4 125 mm / 1400 W Avuç Taşlama



- Sınıfının en düşük gövde çapı (203 mm)
- Hafif ve Kompakt tasarım
- Güçlü 1400 W motor
- Ergonomik tasarım
- Isınmaya karşı dayanıklı
- Güvenlikli tetik sayesinde makine fişe takılıyken enerji kesilmesi ve tekrar gelmesi durumunda motor doğrudan çalışmayarak olası iş kazalarının önüne geçilmiş olur.

MODEL G 13SB4

Güç	1400 W
Disk çapı	125 mm
Mil vidası	M14x2
Devir sayısı	11000 dev/dk
Ağırlık	1.9 kg
Koli Adedi	4



160 \$

Standart aksesuarlar:

1 anahtar, 1 siperlik, 1 yan tutamak

3

BÜYÜK TAŞLAMALAR

G18ST 180 mm / 2200 W Büyük Taşlama



- Güçlü 2200 W Hikoki motoru
- Toz ve yabancı cisim girişinden minimum etkilenen labirent motor yapısı
- Daha çabuk soğumayı sağlayıp motor ömrünü uzatan iki parçalı stator
- Hikoki gücünü yansıtan agresif tasarım

MODEL	G 18ST
Güç	2200 W
Disk çapı	180 mm
Mil vidası	M14x2
Devir sayısı	8500 dev/dk
Ağırlık	4.9 kg
Koli Adedi	4



185 \$

Standart aksesuarlar:

1 anahtar, 1 siperlik, 1 yan tutamak

G23ST 230 mm / 2200 W Büyük Taşlama



- Güçlü 2200 W Hikoki motoru
- Toz ve yabancı cisim girişinden minimum etkilenen labirent motor yapısı
- Daha çabuk soğumayı sağlayıp motor ömrünü uzatan iki parçalı stator
- Hikoki gücünü yansıtan agresif tasarım

MODEL	G 23ST
Güç	2200 W
Disk çapı	230 mm
Mil vidası	M14x2
Devir sayısı	6600 dev/dk
Ağırlık	4.9 kg
Koli Adedi	4



185 \$

Standart aksesuarlar:

1 anahtar, 1 siperlik, 1 yan tutamak

G18SE4 180 mm / 2600 W Büyük Taşlama



- Güçlü 2600 W Hikoki motoru
- Titreşim emici yan kol
- Alet gerekmeden ayarlanabilir disk muhafazası
- Özel geliştirilmiş motor ile daha hafif ve aşırı yükü karşı daha dayanıklı

MODEL	G 18SE4
Güç	2600 W
Disk çapı	180 mm
Mil vidası	M14x2
Devir sayısı	8500 dev/dk
Ağırlık	5.9 kg
Koli Adedi	3



260 \$

Standart aksesuarlar:

1 anahtar, 1 siperlik, 1 yan tutamak

G23SC4 230 mm / 2600 W Büyük Taşlama



- Güçlü 2600 W Hikoki motoru
- Titreşim emici yan kol
- Alet gerekmeden ayarlanabilir disk muhafazası
- Özel geliştirilmiş motor ile daha hafif ve aşırı yükü karşı daha dayanıklı

MODEL	G 23SC4
Güç	2600 W
Disk çapı	230 mm
Mil vidası	M14x2
Devir sayısı	6600 dev/dk
Ağırlık	6.1 kg
Koli Adedi	3



260 \$

Standart aksesuarlar:

1 anahtar, 1 siperlik, 1 yan tutamak

POLİSAJ - KALIPÇI TAŞLAMALAR

SP18VA 180 mm / 1250 W Polisaaj



- Güçlü 1250 W motor
- Sabit hız kontrolü ile daha verimli çalışma
- Yumuşak başlangıç ve aşırı yüklenmeye karşı koruma
- Hem tetikten hem de devir ayar düğmesinden hız değiştirme
- Kompakt ve hafif yapı



MODEL	SP 18VA
Güç	1250 W
Disk çapı	180 mm
Mil vidası	M14x2
Devir sayısı	0-3400 dev/dk
Ağırlık	2.8 kg
Koli Adedi	2

345 \$

Standart aksesuarlar:

1 anahtar, 1 kumlama disk, 1 bone, 1 lastik disk

GP2S2 6 mm / 520 W Kalıpçı Taşlama



- Sınıfında en yüksek taşlama hızı 29 000 dev/dk.
- Kompakt ve ergonomik yeni tasarım
- Tamamı rulmanlı yapı
- Alüminyum alaşımlı dayanıklı ön gövde



MODEL	GP 2S2
Güç	520 W
Max. taş çapı	25 mm
Pens	6 mm
Devir sayısı	29000 dev/dk
Uzunluk	359 mm
Ağırlık	1.7 kg
Koli Adedi	4

305 \$

Standart aksesuarlar:

1 tutamak, 2 anahtar

GP3V 6 mm / 760 W Kalıpçı Taşlama, Devir Ayarlı



- 7000-29000 dev/dk arasında ayarlanabilir devir
- Elektronik kontrol: yavaş başlangıç ve sabit devir
- Maksimum taş çapı: 25 mm



MODEL	GP 3V
Güç	760 W
Maxsimum taş çapı	25 mm
Pens	6 mm
Devir sayısı	7000-29000 dev/dk
Uzunluk	406 mm
Ağırlık	1.8 kg
Koli Adedi	4

460 \$

Standart aksesuarlar:

1 tutamak, 2 anahtar

KIRICI DELİCİLER

DH26PC2 26 mm / 830 W Kırıcı Delici



- 3 mod (delme - darbeli delme - kırıcı)
- Sınıfındaki en yüksek delme hızı*
- Yüksek dayanım
- 830 W güçlü Hikoki motoru
- 3.2 joule darbe kuvveti
- Tek hamlede uç takma sistemi
- 360 derece dönebilen çift katmanlı tutamak



MODEL	DH 26PC2	
Kapasite	Beton	26 mm
	Çelik	13 mm
	Ahşap	32 mm
Güç	830 W	
Darbe kuvveti	3.2 Joule	
Devir sayısı	0-1100 dev/dk	
Darbe sayısı	0-4300dar/dk	
Uç tipi	SDS-Plus	
Ağırlık	2.8 kg	
Koli Adedi	3	

Temmuz 2019 itibari ile 26 mm kırıcı deliciler arasında

Standart aksesuarlar:
1 çanta, 1 tutamak, 1 derinlik mastarı



220 \$

DH28PCY2 28 mm / 850 W Kırıcı Delici



- 3 mod (delme - darbeli delme - kırıcı)
- Hikoki titreşim azaltma teknolojisi (UVP) ile %33 daha az titreşim
- Sınıfının en az titreşimli*
- Yüksek dayanım
- 850 W güçlü Hikoki motoru
- 3.4 joule darbe kuvveti
- Tek hamlede uç takma sistemi



MODEL	DH 28PCY2	
Kapasite	Beton	28 mm
	Çelik	13 mm
	Ahşap	32 mm
Güç	850 W	
Darbe kuvveti	3.4 Joule	
Devir sayısı	0-1100 dev/dk	
Darbe sayısı	0-4300 dar/dk	
Uç tipi	SDS-Plus	
Ağırlık	3.0 kg	
Koli Adedi	3	

* Temmuz 2019 itibariyle DH28PEC hariç 28 mm kırıcı deliciler arasında. (Hikoki Holdings tarafından araştırılmıştır)

Standart aksesuarlar:
1 çanta, 1 tutamak, 1 derinlik mastarı



350 \$

DH40MC 40 mm / 1000 W Kırıcı Delici



- Güçlü motor, 1000 W
- Sınıfındaki en hızlı delici
- Delme modunda emniyet debriyajı
- Düşük titreşim ve sessiz çalışma
- Değişken kilit mekanizmalı SDS-Max uç sistemi.



MODEL	DH 40MC	
Kapasite	Max. delme çapı	40 mm
	Max. karot çapı	105 mm
Güç	1000 W	
Darbe kuvveti	10.5 Joule	
Devir sayısı	0-620 dev/dk	
Darbe sayısı	0-2800dar/dk	
Uç tipi	SDS-Max	
Ağırlık	7.1 kg	
Koli Adedi	2	

Standart aksesuarlar:
1 çanta, 1 tutamak



740 \$

KIRICI DELİCİLER - KIRICI

DH45MA 45 mm /1400 W Kırıcı Delici



- Güçlü motor, 1400 W
- LVH Titreşim emici kol
- Kullanımı rahat büyük tetik
- Devir sayısı ön seçimi
- Değişken kilit mekanizmalı SDS-Max uç sistemi.
- Düşük titreşim ve sessiz çalışma



MODEL	DH 45MA	
Kapasite	Max. delme çapı	45 mm
	Max. karot çapı	125 mm
Güç	1400 W	
Darbe kuvveti	11.3 Joule	
Devir sayısı	260-380 dev/dk	
Darbe sayısı	1750-2900 dar/dk	
Uç tipi	SDS-Max	
Ağırlık	9.4 kg	
Koli Adedi	1	



920 \$

Standart aksesuarlar:

1 çanta, 1 tutamak, 1 derinlik mastarı

DH52MA 52 mm / 1500W Kırıcı Delici



- Güçlü motor, 1500 W
- LVH Titreşim emici kol
- Kullanımı rahat büyük tetik
- Devir sayısı ön seçimi
- Değişken kilit mekanizmalı SDS-Max uç sistemi.
- Düşük titreşim ve sessiz çalışma



MODEL	DH 52MA	
Kapasite	Max. delme çapı	52 mm
	Max. karot çapı	160 mm
Güç	1500 W	
Darbe kuvveti	15.5 Joule	
Devir sayısı	210-330 dev/dk	
Darbe sayısı	1200-2250 dar/dk	
Uç tipi	SDS-Max	
Ağırlık	11.8 kg	
Koli Adedi	1	



1000 \$

Standart aksesuarlar:

1 çanta, 1 tutamak, 1 derinlik mastarı

H60MC 10 kg / 1250 W Kırıcı



- Yüksek kırma performansı; 22 Joule
- Fonksiyonel ve sağlam tasarım
- Titreşim emici tutamak
- SDS-Max uç sistemi



MODEL	H 60MC
Güç	1250 W
Darbe sayısı	1600 dar/dk
Darbe kuvveti	22 Joule
Uzunluk	570 mm
Uç tipi	SDS - Max
Ağırlık	10.2 kg
Koli Adedi	1



1000 \$

Standart aksesuarlar:

1 çanta, 1 tutamak, 1 adet murç

4

KIRICILAR

H65SB3 18 kg / 1340 W Kırıcı



- Kullanıcıyı yüksek titreşimden koruyan UVP özelliği
- Sınıfındaki en yüksek kırma gücü*
- Doğal kauçuktan yapılmış 360° dönebilen yan tutamak
- Yumuşak, kaymayan ve kullanımı kolaylaştıran titreşim emici sap
- Dayanıklı ve sağlam alüminyum gövde
- 30 mm altıgen uç sistemi
- Minimum 2.5 KW jeneratör ile kullanılabilir



MODEL	H 65SB3
Güç	1340 W
Darbe sayısı	1400 dar/dk
Darbe kuvveti	45 Joule
Uzunluk	731 mm
Uç tipi	30 mm Altıgen
Ağırlık	18 kg
Koli Adedi	1



1650 \$

*Ekim 2016 itibari ile 16-18 kg kırıcılar arasında

Standart aksesuarlar
tutamak, 1 adet murç, 1 çanta

H90SG 32 kg / 2000 W Kırıcı



- Kendi sınıfının en yüksek darbe kuvveti*
- UVP teknolojisi sayesinde %54'e varan düşük titreşim
- Rahat kullanım için geliştirilmiş ergonomik sap tasarımı
- 28.5 mm Altıgen uç



MODEL	H 90SG
Güç	2000 W
Darbe sayısı	1000 dar/dk
Darbe kuvveti	70 Joule
Uzunluk	860 mm
Uç tipi	28 mm Altıgen
Ağırlık	32 kg
Koli Adedi	1



2650 \$

*Temmuz 2014 itibari ile 30 kg kırıcılar arasında



PROFİL KESME - DAİRE TESTERE- FREZE

CC14ST 355 mm / 2200 W Profil Kesme



- Yumuşak başlangıç
- 2200 W güçlü motor
- Hızlı kilitleme mekanizması
- Kıvılcım koruyucu
- Mil kilitli



MODEL	CC 14ST
Güç	2200 W
Devir sayısı	3800 dev/dk
Karbon taş çapı	355 mm
Karbon taş göbek çapı	25,4 mm
Kapasite	Boru Ø 130 mm
	Profil 95x200 mm
Ağırlık	17 kg
Koli Adedi	1



335 \$

Standart aksesuarlar
1 kesme taşı, 1 anahtar

C7SS 190 mm / 1050 W Daire Testere



- 190 mm bıçak çapı, 68 mm kesme derinliği
- Güçlü alüminyum taban
- Ayarlanabilir kesme derinliği ve kesme açısı
- Arka toz çıkışı
- Kavramayı kolaylaştıran yan tutamak

MODEL	C 7SS
Güç	1050 W
Devir sayısı	5500 dev/dk
Testere çapı	190 mm
Maksimum kesme derinliği 90°	68 mm
Maksimum kesme derinliği 45°	46 mm
Ağırlık	3.4 kg
Koli Adedi	3



185 \$

Standart aksesuarlar
1 bıçak, 1 anahtar, 1 kılavuz

M12VE 12 mm / 2000 W Freze



- Güçlü 2000 W motor
- Elektronik kontrollü devir ayarı
- Değişken açılı yan tutamak kolları
- Derinlik ayarı için hassas ve kullanımı kolay skala
- Yumuşak kalkış
- Alüminyum alaşımlı taban ve ara kapak
- Hafif, sadece 5.3 kg



MODEL	M 12VE
Güç	2000 W
Devir sayısı	8000-22000/dk
Pens çapı	12 mm
Freze stroku	65 mm
Ağırlık	5.3 kg
Koli Adedi	3



520 \$

Standart aksesuarlar
1 kılavuz, 1 anahtar

GÖNYE KESME - RAYLI GÖNYE KESME

C10FCE2 255 mm / 1520 W Gönye Kesme



- 1520 W güçlü Hikoki motoru
- 48° sola yatar kafa
- 0°-52° sağ/sol döner tabla
- 0°-15°, 22.5°, 31.6° ve 45°'lerde otomatik sabitleme
- Kesilecek malzemenin daha sabit tutulması için genişletilmiş tabla yüzeyi
- Kolay bıçak değişimi için mil kilit mekanizması
- Temiz çalışma için toz torbası



MODEL	C 10FCE2
Güç	1520 W
Devir sayısı	5000 dev/dk
Testere çapı	255 mm
Testere göbek çapı	30 mm
Maksimum kesme derinliği 90°	89x101 mm
Maksimum kesme derinliği 45°	59x102 mm
Ağırlık	11.9 kg
Koli Adedi	1



515 \$

Standart aksesuarlar

1 bıçak, 1 toz torbası, 1 anahtar takımı

C12RSH2 305 mm / 1520 W Raylı Gönye Kesme - Lazerli Kesim Çizgisi



- 630 mm genişliğinde, alüminyum alaşımlı tabla
- Kusursuz ve hızlı kesim için kılavuz lazer ışık
- Her iki yöne 57° ye kadar dönebilen alt tabla
- Sessiz çalışan kayış aktarmalı motor



MODEL	C 12RSH2
Güç	1520 W
Devir sayısı	4000 dev/dk
Testere çapı	305 mm
Testere göbek çapı	30 mm
Maksimum kesme derinliği 0°	105x312 mm
Maksimum kesme derinliği 45°	68x312 mm
Ağırlık	27 kg
Koli Adedi	1



1330 \$

Standart aksesuarlar

1 bıçak, 1 toz torbası, 1 anahtar takımı



EKSANTRİK ZIMPARA - PLANYA - SICAK HAVA TABANCASI

SV13YA 125 mm / 230 W Eksantrik Zımpara



- Avuç içine rahat oturan ergonomik gövde sayesinde kolay kullanım
- Yüksek zımparalama performansı
- Yüksek toz toplama performansı
- Elektronik kontrol özelliği ile farklı devirlerde sabit hız kontrolü
- Rulmanlı yapı



MODEL	SV 13YA
Güç	230 W
Devir sayısı	7000-12000 dev/dk
Kağıt ölçüsü	Ø 125 mm
Taban ölçüsü	Ø 125 mm
Titreşim çapı	3.2 mm
Ağırlık	1.4 kg
Koli Adedi	3



170 \$

Standart aksesuarlar
1 zımpara kağıt, 1 toz torbası

P20ST 82 mm / 580 W Planya



- 580 W motor gücü
- Lamba ölçüsü 9 mm
- Kolay ayarlanabilen kesme derinlik ayarı
- Sadece 2.5 kg

MODEL	P 20ST
Güç	580 W
Kesme genişliği	82 mm
Kesme derinliği	1.5 mm
Devir sayısı	17000 dev/dk
Ağırlık	2.5 kg
Koli Adedi	3



185 \$

Standart aksesuarlar
1 bıçak, 1 bıçak yerleştirme mastarı, 1 kılavuz, 1 anahtar

RH600T 600 °C / 2000 W Sıcak Hava Tabancası



- 450/600 °C çift ısı ayarı
- Hızlı soğutma
- Yüksek ısı koruması
- Rahat ve kontrollü kullanım için yumuşak sap
- Sabit noktada sürekli kullanım için askı kancası

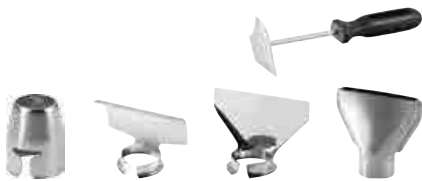

MODEL	RH 600T
Güç	2000 W
Sıcaklık kademeleri	450/600 °C
Fan hızı	250/500 litre/dk
Ağırlık	0.57 kg
Koli Adedi	5



80 \$

Standart aksesuarlar
1 çanta, 4 nozul, 1 raspa

DEKUPAJLAR - TİLKİ KUYRUĞU

CJ65V3 65 mm / 400 W Dekupaj



- Geliştirilmiş endüvi yapısı sayesinde daha uzun kullanım
- Güvenli ve rahat tutuş için yumuşak sap
- Elektronik hız kontrollü büyük tetik
- İstenildiğinde vakum yapabilen bir cihaza takılabilen toz toplama aparatı
- 45° sağ-sol açılı kesim
- Emniyet kapağı
- Hem tetikten hem devir ayar düğmesinden hız değiştirme



MODEL		CJ 65V3
Güç		400 W
Kesme derinliği	Ahşap	65 mm
	Çelik	6 mm
Devir sayısı		0-3000 dev/dk
Strok uzunluğu		18 mm
Ağırlık		1.5 kg
Koli Adedi		5



125 \$

Standart aksesuarlar
1 bıçak, 1 anahtar

CJ90VST2 90 mm / 705 W Dekupaj



- Kompakt tasarım
- Hızlı bıçak değiştirme sistemi
- 4 kademeli yörüngesel hareket.
- 45° sağ-sol kesim imkânı
- Yumuşak ve kullanışlı tutamak
- Toz üfleme fonksiyonu
- Pürüzsüz düz ve kavisli kesimler



MODEL		CJ 90VST2
Güç		705 W
Kesme derinliği	Ahşap	90 mm
	Çelik	10 mm
Min. kesme yarı çapı		25 mm
Devir sayısı		850-3000 dev/dk
Strok uzunluğu		26 mm
Ağırlık		2.2 kg
Koli Adedi		5



200 \$

Standart aksesuarlar
1 çanta, 1 bıçak, 1 anahtar, toz toplayıcı

CR13V2 300 mm / 1010 W Tilki Kuyruğu



- Güçlü 1010 W motor
- Ergonomik tasarım ve sağlam gövde
- Düz kesim
- Anahtarsız testere takabilme özelliği
- Aşağı veya yukarı yönde kesim yapma imkanı sağlayan bıçak mekanizması

MODEL		CR 13V2
Güç		1010 W
Kesme derinliği	Boru	130 mm
	Çelik	19 mm
	Ahşap	300 mm
Strok uzunluğu		29 mm
Strok sayısı		0-2800 dev/dk
Ağırlık		3.3 kg
Koli Adedi		3



320 \$

Standart aksesuarlar
1 çanta, 1 bıçak, 1 anahtar

KL PRO
III®

*Gücün Ustası,
Ustanın Gücü!*

AKÜLÜ GRUBU 30-50

	ŞARJLI DARBESİZ VİDALAMA/MATKAPLAR	30
	ŞARJLI MULTİ SET	32
	ŞARJLI MULTİ SET AKSESUARLAR	32
	ŞARJLI DARBESİZ VİDALAMA/MATKAPLAR	33
	ŞARJLI DARBELİ VİDALAMA/MATKAPLAR	34
	ŞARJLI DARBELİ VİDALAMALAR	36
	ŞARJLI SOMUN SIKMA/SÖKMELER	37
	ŞARJLI SİLİKON TABANCASI	38
	ŞARJLI PNÖMATİK MATKAP	39
	ŞARJLI POLİSAJ MAKİNASI	39
	ŞARJLI AVUÇ TAŞLAMALAR	40
	ŞARJLI DEKUPAJ TESTERE	41
	ŞARJLI TİLKİ KUYRUĞU TESTERE	42
	ŞARJLI DAİRE TESTERE	42
	ŞARJLI EKSANTRİK ZIMPARA	43
	ŞARJLI ÇOK AMAÇLI MAKİNA	43
	ŞARJLI ÇİVİ/ZIMBA ÇAKMA MAKİNASI	44
	ŞARJLI GRES TABANCASI	44
	ŞARJLI ÇAY TOPLAMA MAKİNASI	45
	ŞARJLI ÇİM BİÇME MAKİNASI	46
	ŞARJLI MİSİNALİ ÇİM BİÇME MAKİNASI	46
	ŞARJLI ZİNCİRLİ TESTERE	47
	ŞARJLI ORMAN MOTORLARI	47
	ŞARJLI ÇİT BUDAMA MAKİNALARI	48
	ŞARJLI TİLKİ KUYRUĞU TESTERE	49
	ŞARJLI BUDAMA MAKASI	49
	ŞARJLI YAPRAK ÜFLEME MAKİNASI	50
	ŞARJ CİHAZLARI	50
	AKÜ UZATMA APARATI	50
	LI-ION AKÜLER	50



LAZER GRUBU 51-54

	LAZER DİSTOMATLAR	51
	OPTİK NİVO	53
	LAZER DİSTOMAT AKSESUARLARI	53
	LAZER MESAFE ÖLÇERLER	54
	TRİPOD	54

ELEKTRİKLİ GRUBU 55-71

	DARBESİZ MATKAPLAR	55
	ALÇIPAN VİDALAMA	55
	DARBELİ MATKAPLAR	56
	ELEKTRİKLİ SOMUN SIKMA / SÖKME	56
	PNÖMATİK MATKAPLAR (SDS-PLUS)	57
	KIRICI/DELİCİLER	58
	KIRICILAR	59
	TAŞIMA ARABASI	60
	AVUÇ TAŞLAMALAR	61
	BÜYÜK TAŞLAMALAR	63
	KALIPÇI TAŞLAMALAR	64
	ALÇIPAN ZIMPARA MAKİNASI	64
	POLİSAJ MAKİNALARI	65
	PROFİL KESMELER	65
	DUVAR KANAL AÇMA MAKİNASI	66
	ÇOK AMAÇLI MAKİNA	66
	TAŞ MOTORLARI	66
	DEKUPAJ TESTERELER	67
	TİLKİ KUYRUĞU TESTERELER	67
	DAİRE TESTERELER	68
	SERAMİK KESME MAKİNASI	68
	PLANYA	68
	EL FREZESİ	69
	ÜFLEME MAKİNASI	69
	SICAK HAVA TABANCASI	70
	TİTREŞİMLİ ve EKSANTRİK ZİMPARALAR	70
	GÖNYE KESME MAKİNALARI	71

ELEKTRİKLİ GRUBU 72-82

	KARIŞTIRICILAR	72
	ELEKTRİKLİ BETON VİBRATÖRÜ - HORTUMLARI	72
	KAYNAK MAKİNALARI	73
	GAZ ALTI KAYNAK MAKİNALARI	74
	İNVERTÖR GAZSIZ GAZ ALTI KAYNAK MAKİNASI	76
	İNVERTÖR PLAZMA KESME MAKİNASI	76
	KOMPRESÖRLER	77
	SESSİZ KOMPRESÖRLER	78
	BASINÇLI YIKAMA MAKİNALARI	80
	ELEKTRİKLİ VİNÇLER	81
	ELEKTRİKLİ ÇİVİ/ZIMBA ÇAKMA MAKİNALARI	82

HAVALI GRUBU 83-88

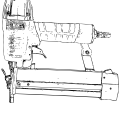
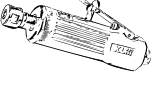
	HAVALI ÇİVİ ÇAKMA MAKİNALARI	83
	HAVALI ÇİVİ/ZIMBA ÇAKMA MAKİNASI	83
	HAVALI ZIMBA ÇAKMA MAKİNALARI	84
	HAVALI DARBELİ SOMUN SIKMA/SÖKMELER	85
	HAVALI DARBELİ SOMUN SIKMA/SÖKME SETİ	85
	HAVALI CİRCİR	86
	HAVALI TORNAVİDA	86
	HAVALI MATKAP	86
	HAVALI ÇEKİÇ KESKİ MAKİNASI	86
	HAVALI KALIPÇI TAŞLAMA	87
	HAVALI EKSANTRİK DAİRESEL ZIMPARA	87
	HAVALI AVUÇ TAŞLAMA	87
	HAVALI POP PERÇİN PENSESİ	87
	HAVALI GRES TABANCASI	88
	HAVALI SİLİKON TABANCASI	88

AKSESUARLAR 91-92

	BİTS UÇ SETİ	91
	BETON DELME UÇ SETİ	91
	DELME VE VİDALAMA SETİ	91
	MAKİNA BIÇAĞI(TİLKİ KUYRUĞU TESTERE BIÇAĞI)	91
	ZİMBALAR	92
	ÇİVİLER	92

KLECO 94-99

	ŞARJLI DARBESİZ VİDALAMA/MATKAP	94
	ŞARJLI DARBELİ VİDALAMA/MATKAPLAR	94
	DARBELİ MATKAP	96
	PNÖMATİK MATKAP	96
	AVUÇ TAŞLAMA	96
	DEVİR AYARLI AVUÇ TAŞLAMA	96
	POLİSAJ MAKİNASI	97
	BÜYÜK TAŞLAMALAR	97
	GRAVÜR TAŞLAMA	97
	EKSANTRİK ZIMPARA	98
	DEKUPAJ TESTERE	98
	DAİRE TESTERE	98
	SICAK HAVA TABANCASI	98
	LAZERMETRE	98
	KAYNAK MAKİNASI	99
	KARIŞTIRICI	99
	ŞARJ CİHAZLARI	99
	LI-ION AKÜLER	99



3.6 Volt



1.5 Ah



Li-Ion



1/4" (6.35 mm)



200 dev/dk

- 44 PARÇA AKSESUAR SETİ
- KİLİTLİ UÇ TUTUCU
- DÖNEBİLİR SAP
- LED FENER

KLNM3613**25 \$**

Sağ-Sol	✓
Akü	3.6 V / 1.5 Ah Li-Ion
Maksimum Tork	3.5 Nm
Yüksüz Hızı	200 dev/dk
Mandren Kapasitesi	1/4" (6.35 mm)
Tork Ayarı	6+1
Taşıma Çantası	✓
Koli Adedi	10



3.6 Volt



2.0 Ah



Li-Ion



1/4" (6.35 mm)



290 dev/dk

- 25 PARÇA AKSESUAR SETİ
- PLASTİK TAŞIMA ÇANTASI

KLN3820**32 \$**

Sağ-Sol	✓
Akü	3.6 V / 2.0 Ah Li-Ion
Maksimum Tork	5 Nm
Yüksüz Hızı	290 dev/dk
Mandren Kapasitesi	1/4" (6.35 mm)
Tork Ayarı	4
Taşıma Çantası	✓
Koli Adedi	10



10.8-12 Volt



2.0 Ah



Li-Ion



Çift Akü



10 mm



0-500 dev/dk

KLDAM1020**100 \$**

Elektronik / Sağ-Sol	✓ / ✓
Akü	10.8-12 V / 2.0 Ah Li-Ion
Maksimum Tork	12 Nm
Yüksüz Hızı	0-500 dev/dk
Mandren Kapasitesi	10 mm
Taşıma Çantası / Çift Akü	✓ (Bez Çanta) / ✓
Koli Adedi	4

ŞARJLI DARBESİZ VİDALAMA/MATKAPLAR



- VİDALAMA İÇİN ÇIKARILABİLEN MANDREN
- STANDART AKSESUARLAR 12 PARÇA UÇ SETİ

Voltaj 10.8-12 Volt	Amper 2.0 Ah	Akü Li-Ion
Çift Akü	Mandren Kapasitesi 0.8-10 mm	Yüksüz Hızı 0-350/0-1300 dev/dk

KLN1020

85 \$

Elektronik / Sağ-Sol	✓ / ✓
Akü	10.8-12 V / 2.0 Ah Li-Ion
Maksimum Tork	30 Nm
Yüksüz Hızı	0-350/0-1300 dev/dk
Mandren Kapasitesi	0.8-10 mm
Tork Ayarı	19+1
Taşıma Çantası / Çift Akü	✓ / ✓
Koli Adedi	2



- VİDALAMA İÇİN ÇIKARILABİLEN MANDREN
- KÖŞE & KENAR VİDALAMA APARATI
- STANDART AKSESUARLAR 12 PARÇA UÇ SETİ

Voltaj 10.8-12 Volt	Amper 2.0 Ah	Akü Li-Ion
Çift Akü	Mandren Kapasitesi 0.8-10 mm	Yüksüz Hızı 0-350/0-1300 dev/dk

KLN1020S

103 \$

Elektronik / Sağ-Sol	✓ / ✓
Akü	10.8-12 V / 2.0 Ah Li-Ion
Maksimum Tork	30 Nm
Yüksüz Hızı	0-350/0-1300 dev/dk
Mandren Kapasitesi	0.8-10 mm
Tork Ayarı	19+1
Taşıma Çantası / Çift Akü	✓ (Bez Çanta) / ✓
Koli Adedi	2

ŞARJLI MULTİ SET



Darbeli Matkap / Vidalama

Maksimum Tork	25 Nm
Tork Ayarı	20+3
Mandren Kapasitesi	10 mm
Vites	2



Daire Testere

Yüksüz Hızı	0-4000 dev/dk
Bıçak Çapı	85 mm
Maks. Kesme Derinliği	15 mm



Dekupaj Testere

Yüksüz Hızı	2200 dev/dk
Strok Uzunluğu	15 mm



Çok Amaçlı Alet

Yüksüz Hızı	0-16000 tit/dk
-------------	----------------

Voltaj



18 Volt

Amper



2.0 Ah

Akü



Li-Ion



Çift Akü

KLMS18-20

200 \$

Elektronik	✓
Akü	18 V / 2.0 Ah Li-Ion
Taşıma Çantası / Çift Akü	✓ (Bez Çanta) / ✓
Koli Adedi	2



ŞARJLI MULTİ SET AKSESUARLAR



**KLMST01
Tilki Kuyruğu**

27 \$

Yüksüz Hızı	0-3000 dev/dk
Stroke Uzunluğu	22 mm
Kesme Kapasitesi	Ahşap: 100 mm Metal: 6 mm



**KLMH03
Hava Kompresörü**

22 \$

Çalışma Basıncı	10 Bar
-----------------	--------



**KLMSV04
Darbeli Vidalama**

22 \$

Yüksüz Hızı	0-2600 dev/dk
Maks. Tork	180 Nm



**KLMSF02
Freze**

20 \$

Yüksüz Hızı	0-7000 / dk
-------------	-------------



**KLMSZ04
Zımpara**

15 \$

Yüksüz Hızı	0-9000 dev/dk
Zımpara Kağıdı	150x150x95 mm

ŞARJLI DARBESİZ VİDALAMA/MATKAPLAR



Taşıma Çantası



KLC240 (2.4 A)
Şarj Cihazı



KLC450 (4.5 A)
Şarj Cihazı



Bataryalar

KLNM18-00	Tek Makina (Çanta içinde)	47 \$
KLNM18-20	2.0 Ah (2 x KLA1820 Batarya) (1 x 2.4 A Şarj Cihazı)	115 \$
KLNM18-50	5.0 Ah (2 x KLA1850 Batarya) (1 x 4.5 A Şarj Cihazı)	193 \$
KLNM18-80	8.0 Ah (2 x KLA1880 Batarya) (1 x 4.5 A Şarj Cihazı)	255 \$



KLNM18

Elektronik / Sağ-Sol	<input checked="" type="checkbox"/> / <input checked="" type="checkbox"/>
Akü	18 V
Maksimum Tork	45 Nm
Yüksüz Hızı	0-350/0-1200 dev/dk
Mandren Kapasitesi	2-13 mm
Tork Ayarı	19+1
Taşıma Çantası	<input checked="" type="checkbox"/>
Koli Adedi	2



Taşıma Çantası



KLC240 (2.4 A)
Şarj Cihazı



KLC450 (4.5 A)
Şarj Cihazı



Bataryalar

KLNM18B-00	Tek Makina (Çanta içinde)	80 \$
KLNM18B-20	2.0 Ah (2 x KLA1820 Batarya) (1 x 2.4 A Şarj Cihazı)	150 \$
KLNM18B-50	5.0 Ah (2 x KLA1850 Batarya) (1 x 4.5 A Şarj Cihazı)	225 \$
KLNM18B-80	8.0 Ah (2 x KLA1880 Batarya) (1 x 4.5 A Şarj Cihazı)	285 \$



KLNM18B

Elektronik / Sağ-Sol	<input checked="" type="checkbox"/> / <input checked="" type="checkbox"/>
Akü	18 V
Maksimum Tork	60 Nm
Yüksüz Hızı	0-500/0-1800 dev/dk
Mandren Kapasitesi	2-13 mm
Tork Ayarı	19+1
Taşıma Çantası	<input checked="" type="checkbox"/>
Koli Adedi	2

ŞARJLI DARBELİ VİDALAMA/MATKAPLAR



Taşıma Çantası



KLC240 (2.4 A)
Şarj Cihazı



KLC450 (4.5 A)
Şarj Cihazı



Bataryalar

KLDM18-00	Tek Makina (Çanta İçinde)	55 \$
KLDM18-20	2.0 Ah (2 x KLA1820 Batarya) (1 x 2.4 A Şarj Cihazı)	120 \$
KLDM18-50	5.0 Ah (2 x KLA1850 Batarya) (1 x 4.5 A Şarj Cihazı)	195 \$
KLDM18-80	8.0 Ah (2 x KLA1880 Batarya) (1 x 4.5 A Şarj Cihazı)	260 \$



Voltaj	Yüksüz Hızı	Mandren Kapasitesi
18 Volt	0-350/0-1200 dev/dk	2-13 mm

KLDM18

Elektronik / Sağ-Sol	<input checked="" type="checkbox"/> / <input checked="" type="checkbox"/>
Akü	18 V
Maksimum Tork	45 Nm
Yüksüz Hızı	0-350/0-1200 dev/dk
Darbe Oranı	0-6000/0-20000 dar/dk
Mandren Kapasitesi	2-13 mm
Tork Ayarı	16+3
Taşıma Çantası	<input checked="" type="checkbox"/>
Koli Adedi	2



Taşıma Çantası



KLC240 (2.4 A)
Şarj Cihazı



KLC450 (4.5 A)
Şarj Cihazı



Bataryalar

KLDM18B-00	Tek Makina (Çanta İçinde)	85 \$
KLDM18B-20	2.0 Ah (2 x KLA1820 Batarya) (1 x 2.4 A Şarj Cihazı)	150 \$
KLDM18B-50	5.0 Ah (2 x KLA1850 Batarya) (1 x 4.5 A Şarj Cihazı)	230 \$
KLDM18B-80	8.0 Ah (2 x KLA1880 Batarya) (1 x 4.5 A Şarj Cihazı)	290 \$



Voltaj	Yüksüz Hızı	Mandren Kapasitesi
18 Volt	0-500/0-1800 dev/dk	2-13 mm

KLDM18B

Elektronik / Sağ-Sol	<input checked="" type="checkbox"/> / <input checked="" type="checkbox"/>
Akü	18 V
Maksimum Tork	60 Nm
Yüksüz Hızı	0-500/0-1800 dev/dk
Darbe Oranı	0-28800 dar/dk
Mandren Kapasitesi	2-13 mm
Tork Ayarı	20+3
Taşıma Çantası	<input checked="" type="checkbox"/>
Koli Adedi	2

ŞARJLI DARBELİ VİDALAMA/MATKAPLAR



Taşıma Çantası



KLC240 (2.4 A)
Şarj Cihazı



KLC450 (4.5 A)
Şarj Cihazı



Bataryalar

KLDM18BH-00	Tek Makina (Çanta içinde)	105 \$
KLDM18BH-20	2.0 Ah (2 x KLA1820 Batarya) (1 x 2.4 A Şarj Cihazı)	170 \$
KLDM18BH-50	5.0 Ah (2 x KLA1850 Batarya) (1 x 4.5 A Şarj Cihazı)	250 \$
KLDM18BH-80	8.0 Ah (2 x KLA1880 Batarya) (1 x 4.5 A Şarj Cihazı)	310 \$



KÖMÜRSÜZ



Voltaj
18 Volt



Yüksüz Hızı
0-550/0-2000 dev/dk



Mandren Kapasitesi
2-13 mm

KLDM18BH

Elektronik / Sağ-Sol	✓ / ✓
Akü	18 V
Maksimum Tork	70 Nm
Yüksüz Hızı	0-550/0-2000 dev/dk
Darbe Oranı	0-8800/0-32000 dar/dk
Mandren Kapasitesi	2-13 mm
Tork Ayarı	20+3
Taşıma Çantası	✓
Koli Adedi	2



Taşıma Çantası



KLC240 (2.4 A)
Şarj Cihazı



KLC450 (4.5 A)
Şarj Cihazı



Bataryalar

KLDM18BHX-00	Tek Makina (Çanta içinde)	135 \$
KLDM18BHX-20	2.0 Ah (2 x KLA1820 Batarya) (1 x 2.4 A Şarj Cihazı)	205 \$
KLDM18BHX-50	5.0 Ah (2 x KLA1850 Batarya) (1 x 4.5 A Şarj Cihazı)	280 \$
KLDM18BHX-80	8.0 Ah (2 x KLA1880 Batarya) (1 x 4.5 A Şarj Cihazı)	350 \$



KÖMÜRSÜZ



Voltaj
18 Volt



Yüksüz Hızı
0-550/0-2200 dev/dk



Mandren Kapasitesi
2-13 mm

KLDM18BHX

Elektronik / Sağ-Sol	✓ / ✓
Akü	18 V
Maksimum Tork	150 Nm
Yüksüz Hızı	0-550/0-2200 dev/dk
Darbe Oranı	0-8250/0-33000 dar/dk
Mandren Kapasitesi	2-13 mm
Tork Ayarı	25+3
Taşıma Çantası	✓
Koli Adedi	2

150 Nm MAKS. TORK

ŞARJLI DARBELİ VIDALAMALAR



Taşıma Çantası



KLC240 (2.4 A)
Şarj Cihazı



KLC450 (4.5 A)
Şarj Cihazı



Bataryalar

KLDV18B-00	Tek Makina (Çanta içinde)	85 \$
KLDV18B-20	2.0 Ah (2 x KLA1820 Batarya) (1 x 2.4 A Şarj Cihazı)	150 \$
KLDV18B-50	5.0 Ah (2 x KLA1850 Batarya) (1 x 4.5 A Şarj Cihazı)	230 \$
KLDV18B-80	8.0 Ah (2 x KLA1880 Batarya) (1 x 4.5 A Şarj Cihazı)	290 \$



KÖMÜRSÜZ

Voltaj	Yüksüz Hızı	Uç Kovanı
18 Volt	0-2200 dev/dk	6 mm

KLDV18B

Elektronik / Sağ-Sol	✓ / ✓
Akü	18 V
Maksimum Tork	180 Nm
Yüksüz Hızı	0-2200 dev/dk
Darbe Oranı	0-3300 dar/dk
Uç Kovanı	6 mm
Taşıma Çantası	✓
Koli Adedi	2



Taşıma Çantası



KLC240 (2.4 A)
Şarj Cihazı



KLC450 (4.5 A)
Şarj Cihazı



Bataryalar

KLDV18BH-00	Tek Makina (Çanta içinde)	96 \$
KLDV18BH-20	2.0 Ah (2 x KLA1820 Batarya) (1 x 2.4 A Şarj Cihazı)	165 \$
KLDV18BH-50	5.0 Ah (2 x KLA1850 Batarya) (1 x 4.5 A Şarj Cihazı)	240 \$
KLDV18BH-80	8.0 Ah (2 x KLA1880 Batarya) (1 x 4.5 A Şarj Cihazı)	305 \$



**3 KADEMELİ ELEKTRONİK
TORK AYARI (100 Nm,
150 Nm, 220 Nm)**

KÖMÜRSÜZ

Voltaj	Yüksüz Hızı	Uç Kovanı
18 Volt	0-2700 dev/dk	6 mm

KLDV18BH

Elektronik / Sağ-Sol	✓ / ✓
Akü	18 V
Maksimum Tork	220 Nm
Yüksüz Hızı	0-2700 dev/dk
Darbe Oranı	0-3400 dar/dk
Uç Kovanı	6 mm
Taşıma Çantası	✓
Koli Adedi	2

ŞARJLI SOMUN SIKMA/SÖKMELER



Taşıma Çantası



KLC240 (2.4 A)
Şarj Cihazı



KLC450 (4.5 A)
Şarj Cihazı



Bataryalar

KLSS18B-00	Tek Makina (Çanta içinde)	95 \$
KLSS18B-20	2.0 Ah (2 x KLA1820 Batarya) (1 x 2.4 A Şarj Cihazı)	165 \$
KLSS18B-50	5.0 Ah (2 x KLA1850 Batarya) (1 x 4.5 A Şarj Cihazı)	240 \$
KLSS18B-80	8.0 Ah (2 x KLA1880 Batarya) (1 x 4.5 A Şarj Cihazı)	300 \$



KÖMÜRSÜZ

Voltaj



18 Volt

Yüksüz Hızı



0-2200 dev/dk

Uç Kovanı



1/2"

KLSS18B

Elektronik / Sağ-Sol	✓ / ✓
Akü	18 V
Maksimum Tork	250 Nm
Yüksüz Hızı	0-2200 dev/dk
Darbe Oranı	0-3300 dar/dk
Uç Kovanı	1/2 inç
Taşıma Çantası	✓
Koli Adedi	2



Taşıma Çantası



KLC240 (2.4 A)
Şarj Cihazı



KLC450 (4.5 A)
Şarj Cihazı



Bataryalar

KLSS18BH-00	Tek Makina (Çanta içinde)	125 \$
KLSS18BH-20	2.0 Ah (2 x KLA1820 Batarya) (1 x 2.4 A Şarj Cihazı)	195 \$
KLSS18BH-50	5.0 Ah (2 x KLA1850 Batarya) (1 x 4.5 A Şarj Cihazı)	270 \$
KLSS18BH-80	8.0 Ah (2 x KLA1880 Batarya) (1 x 4.5 A Şarj Cihazı)	335 \$

5 KADEMELİ ELEKTRONİK TORK AYARI (100 Nm, 150 Nm, 200 Nm, 300 Nm, 400 Nm)



KÖMÜRSÜZ

Voltaj



18 Volt

Yüksüz Hızı



0-2200 dev/dk

Uç Kovanı



1/2"

KLSS18BH

Elektronik / Sağ-Sol	✓ / ✓
Akü	18 V
Maksimum Tork	400 Nm
Yüksüz Hızı	0-2200 dev/dk
Darbe Oranı	0-3300 dar/dk
Uç Kovanı	1/2 inç
Taşıma Çantası	✓
Koli Adedi	2

ŞARJLI SOMUN SIKMA/SÖKME



Taşıma Çantası



KLC240 (2.4 A)
Şarj Cihazı



KLC450 (4.5 A)
Şarj Cihazı



Bataryalar



KLSS18BHX-00	Tek Makina (Çanta İçinde)	170 \$
KLSS18BHX-20	2.0 Ah (2 x KLA1820 Batarya) (1 x 2.4 A Şarj Cihazı)	235 \$
KLSS18BHX-50	5.0 Ah (2 x KLA1850 Batarya) (1 x 4.5 A Şarj Cihazı)	310 \$
KLSS18BHX-80	8.0 Ah (2 x KLA1880 Batarya) (1 x 4.5 A Şarj Cihazı)	380 \$

5 KADEMELİ ELEKTRONİK TORK AYARI

KÖMÜRSÜZ

Voltaj



18 Volt

Yüksüz Hızı



0-1800 dev/dk

Uç Kovanı



1/2"

KLSS18BHX

Elektronik / Sağ-Sol	✓ / ✓
Akü	18 V
Maksimum Tork	800 Nm
Yüksüz Hızı	0-1800 dev/dk
Darbe Oranı	0-2200 dar/dk
Uç Kovanı	1/2"
Taşıma Çantası	✓
Koli Adedi	2

ŞARJLI SİLİKON TABANCASI



KLC240 (2.4 A)
Şarj Cihazı



KLC450 (4.5 A)
Şarj Cihazı



Bataryalar



**ÖNCEKİ MODELE GÖRE
2.4 KAT FAZLA İTME KUVVETİ**
TETİK SABİTLEYİCİ
DEVİR AYARLI

KLST18E-00	Tek Makina (Çanta İçinde)	95 \$
KLST18E-20	2.0 Ah (2 x KLA1820 Batarya) (1 x 2.4 A Şarj Cihazı)	165 \$
KLST18E-50	5.0 Ah (2 x KLA1850 Batarya) (1 x 4.5 A Şarj Cihazı)	240 \$
KLST18E-80	8.0 Ah (2 x KLA1880 Batarya) (1 x 4.5 A Şarj Cihazı)	305 \$
KLSTS01	Sosis Tabancası Haricen satılır	26 \$

Voltaj



18 Volt

İtme Kuvveti



6000 N

KLST18E

Elektronik	✓
Akü	18 V
İtme Hızı	0-8,5 mm/s
Maksimum İtme Kuvveti	6000 N
Taşıma Çantası	—
Koli Adedi	2



KLSTS01

600 ml Sosis Tabancası

ŞARJLI PNÖMATİK MATKAP



Taşıma Çantası



KLC240 (2.4 A)
Şarj Cihazı



KLC450 (4.5 A)
Şarj Cihazı



Bataryalar

KLPM18BH-00	Tek Makina (Çanta içinde)	145 \$
KLPM18BH-20	2.0 Ah (2 x KLA1820 Batarya) (1 x 2.4 A Şarj Cihazı)	215 \$
KLPM18BH-50	5.0 Ah (2 x KLA1850 Batarya) (1 x 4.5 A Şarj Cihazı)	290 \$
KLPM18BH-80	8.0 Ah (2 x KLA1880 Batarya) (1 x 4.5 A Şarj Cihazı)	350 \$

4 FARKLI KULLANIM MODU

SDS PLUS ADAPTÖRLÜ MANDREN

2.8 JOULE DARBE GÜCÜ



KÖMÜRSÜZ

Voltaj	Betonda Delme Kapasitesi	Darbe Gücü	Uç Tutucu
18 Volt	26 mm	2.8 J	SDS PLUS

KLPM18BH

Elektronik / Sağ-Sol	✓ / ✓
Akü	18 V
Yüksüz Hızı	0-1150 dev/dk
Darbe Oranı	0-5100 dar/dk
Darbe Gücü	2.8 J
Betonda Delme Kapasitesi	26 mm
Taşıma Çantası	✓ (Bez Çanta)
Koli Adedi	2

ŞARJLI POLİSAJ MAKİNASI



Taşıma Çantası



KLC240 (2.4 A)
Şarj Cihazı



KLC450 (4.5 A)
Şarj Cihazı



Bataryalar

KLPS18B-00	Tek Makina (Çanta içinde)	95 \$
KLPS18B-20	2.0 Ah (2 x KLA1820 Batarya) (1 x 2.4 A Şarj Cihazı)	165 \$
KLPS18B-50	5.0 Ah (2 x KLA1850 Batarya) (1 x 4.5 A Şarj Cihazı)	240 \$
KLPS18B-80	8.0 Ah (2 x KLA1880 Batarya) (1 x 4.5 A Şarj Cihazı)	305 \$



LED EKРАН İLE
DİJİTAL DEVİR AYARI
ORBİTAL DÖNÜŞ

Aksesuar
2 adet sünger

KÖMÜRSÜZ

Voltaj	Yüksüz Hızı	Disk Çapı
18 Volt	2000-4800 dev/dk	125 mm

KLPS18B

Elektronik	✓
Akü	18 V
Disk Çapı	125 mm
Yüksüz Hızı	2000-4800 dev/dk
Eksantriklik Derecesi	15 mm
Taşıma Çantası	✓ (Bez Çanta)
Koli Adedi	2

ŞARJLI AVUÇ TAŞLAMALAR



Taşıma Çantası



KLC240 (2.4 A)
Şarj Cihazı



KLC450 (4.5 A)
Şarj Cihazı



Bataryalar

KLAT18B-00	Tek Makina (Çanta içinde)	90 \$
KLAT18B-20	2.0 Ah (2 x KLA1820 Batarya) (1 x 2.4 A Şarj Cihazı)	157 \$
KLAT18B-50	5.0 Ah (2 x KLA1850 Batarya) (1 x 4.5 A Şarj Cihazı)	234 \$
KLAT18B-80	8.0 Ah (2 x KLA1880 Batarya) (1 x 4.5 A Şarj Cihazı)	297 \$



KÖMÜRSÜZ

Voltaj	Yüksüz Hızı	Disk Çapı
18 Volt	0-8500 dev/dk	115 mm

KLAT18B

Elektronik	<input checked="" type="checkbox"/>
Akü	18 V
Disk Çapı	115 mm
Yüksüz Hızı	8500 dev/dk
Mil Bağlantı Dişi	M14
Taşıma Çantası	<input checked="" type="checkbox"/> (Bez Çanta)
Koli Adedi	2



Taşıma Çantası



KLC240 (2.4 A)
Şarj Cihazı



KLC450 (4.5 A)
Şarj Cihazı



Bataryalar

KLAT18BS-00	Tek Makina (Çanta içinde)	110 \$
KLAT18BS-20	2.0 Ah (2 x KLA1820 Batarya) (1 x 2.4 A Şarj Cihazı)	177 \$
KLAT18BS-50	5.0 Ah (2 x KLA1850 Batarya) (1 x 4.5 A Şarj Cihazı)	254 \$
KLAT18BS-80	8.0 Ah (2 x KLA1880 Batarya) (1 x 4.5 A Şarj Cihazı)	317 \$



DEVİR AYARLI

KÖMÜRSÜZ

Voltaj	Yüksüz Hızı	Disk Çapı
18 Volt	500-10000 dev/dk	115 mm

KLAT18BS

Elektronik	<input checked="" type="checkbox"/>
Akü	18 V
Disk Çapı	115 mm
Yüksüz Hızı	500-10000 dev/dk
Mil Bağlantı Dişi	M14
Taşıma Çantası	<input checked="" type="checkbox"/>
Koli Adedi	2

/// ŞARJLI DEKUPAJ TESTERE



Taşıma Çantası



KLC240 (2.4 A)
Şarj Cihazı



KLC450 (4.5 A)
Şarj Cihazı



Bataryalar



/// HIZLI BIÇAK DEĞİŞTİRME SİSTEMİ
/// PANDÜL HAREKETİ

KÖMÜRSÜZ

Voltaj

Yüksüz Hızı

Açılı Kesim



18 Volt

0-3000 dev/dk

45 Derece

KLDT18B

Elektronik



Akü

18 V

Yüksüz Hızı

0-3000 dev/dk

Kesme Kapasitesi

90/10/25 mm

Ahşap/Metal/Alüminyum

Kesim Açısı

0-45°

Pandül Hareketi



Taşıma Çantası

✓ (Bez Çanta)

Koli Adedi

2

KLDT18B-00	Tek Makina (Çanta içinde)	105 \$
KLDT18B-20	2.0 Ah (2 x KLA1820 Batarya) (1 x 2.4 A Şarj Cihazı)	175 \$
KLDT18B-50	5.0 Ah (2 x KLA1850 Batarya) (1 x 4.5 A Şarj Cihazı)	250 \$
KLDT18B-80	8.0 Ah (2 x KLA1880 Batarya) (1 x 4.5 A Şarj Cihazı)	315 \$



ŞARJLI TILKI KUYRUĞU TESTERE



Taşıma Çantası



KLC240 (2.4 A)
Şarj Cihazı



KLC450 (4.5 A)
Şarj Cihazı



Bataryalar



Aksesuar
2 adet bıçak

KLTKT18B-00	Tek Makina (Çanta İçinde)	105 \$
KLTKT18B-20	2.0 Ah (2 x KLA1820 Batarya) (1 x 2.4 A Şarj Cihazı)	175 \$
KLTKT18B-50	5.0 Ah (2 x KLA1850 Batarya) (1 x 4.5 A Şarj Cihazı)	250 \$
KLTKT18B-80	8.0 Ah (2 x KLA1880 Batarya) (1 x 4.5 A Şarj Cihazı)	315 \$

HIZLI BIÇAK DEĞİŞTİRME SİSTEMİ

KÖMÜRSÜZ



KLTKT18B

Elektronik	✓
Akü	18 V
Yüksüz Hızı	0-3000 dev/dk
Derinlik Hareketi	26 mm
Taşıma Çantası	✓ (Bez Çanta)
Koli Adedi	2

ŞARJLI DAİRE TESTERE



Taşıma Çantası



KLC240 (2.4 A)
Şarj Cihazı



KLC450 (4.5 A)
Şarj Cihazı



Bataryalar



Aksesuar
Alyan
Bıçak

HIZLI FREN SİSTEMİ

KÖMÜRSÜZ



KLDAT18B

KLDAT18B-00	Tek Makina (Çanta İçinde)	110 \$
KLDAT18B-20	2.0 Ah (2 x KLA1820 Batarya) (1 x 2.4 A Şarj Cihazı)	180 \$
KLDAT18B-50	5.0 Ah (2 x KLA1850 Batarya) (1 x 4.5 A Şarj Cihazı)	255 \$
KLDAT18B-80	8.0 Ah (2 x KLA1880 Batarya) (1 x 4.5 A Şarj Cihazı)	320 \$

Elektronik	✓
Akü	18 V
Yüksüz Hızı	0-3650 dev/dk
Bıçak Çapı	165 mm
90° Kesme Derinliği	50 mm
45° Kesme Derinliği	35 mm
Taşıma Çantası	✓ (Bez Çanta)
Koli Adedi	2

ŞARJLI EKSANTRİK ZIMPARA



KLC240 (2.4 A)
Şarj Cihazı



KLC450 (4.5 A)
Şarj Cihazı



Bataryalar



KLEZ18-00	Tek Makina (Çanta içinde)	35 \$
KLEZ18-20	2.0 Ah (2 x KLA1820 Batarya) (1 x 2.4 A Şarj Cihazı)	105 \$
KLEZ18-50	5.0 Ah (2 x KLA1850 Batarya) (1 x 4.5 A Şarj Cihazı)	180 \$
KLEZ18-80	8.0 Ah (2 x KLA1880 Batarya) (1 x 4.5 A Şarj Cihazı)	245 \$

Aksesuar
1 adet zımpara kağıdı

KLEZ18

Elektronik	✓
Akü	18 V
Yüksüz Hızı	10000 dev/dk
Kağıt Ölçüsü	125 mm
Taşıma Çantası	–
Koli Adedi	5

ŞARJLI ÇOK AMAÇLI MAKİNA



Taşıma Çantası



KLC240 (2.4 A)
Şarj Cihazı



KLC450 (4.5 A)
Şarj Cihazı



Bataryalar



KLMT18B-00	Tek Makina (Çanta içinde)	100 \$
KLMT18B-20	2.0 Ah (2 x KLA1820 Batarya) (1 x 2.4 A Şarj Cihazı)	170 \$
KLMT18B-50	5.0 Ah (2 x KLA1850 Batarya) (1 x 4.5 A Şarj Cihazı)	245 \$
KLMT18B-80	8.0 Ah (2 x KLA1880 Batarya) (1 x 4.5 A Şarj Cihazı)	310 \$

KÖMÜRSÜZ

KLMT18B

Elektronik	✓
Akü	18 V
Dakikada Titreşim Sayısı	5000-19000 tit/dk
Titreşim Açısı	3°
Taşıma Çantası	✓
Koli Adedi	2

4 PARÇALI AKSESUAR SETİ

ŞARJLI ÇİVİ / ZIMBA ÇAKMA MAKİNASI



Taşıma Çantası



KLC240 (2.4 A)
Şarj Cihazı



KLC450 (4.5 A)
Şarj Cihazı



Bataryalar

KLZC18-00	Tek Makina (Çanta içinde)	145 \$
KLZC18-20	2.0 Ah (2 x KLA1820 Batarya) (1 x 2.4 A Şarj Cihazı)	215 \$
KLZC18-50	5.0 Ah (2 x KLA1850 Batarya) (1 x 4.5 A Şarj Cihazı)	290 \$
KLZC18-80	8.0 Ah (2 x KLA1880 Batarya) (1 x 4.5 A Şarj Cihazı)	350 \$

DAKİKADA 60 ADET ÇİVİ/ZIMBA ÇAKAR



Çivi Uzunluğu	Zimba Uzunluğu	Vuruş Hızı	Kartuş Kapasitesi
20-50 mm	19-40 mm	60 Adet/dk	Çivi: 100 Zimba: 100

KLZC18

Elektronik	<input checked="" type="checkbox"/>
Akü	18 V
Zimba Uzunluğu	19-40 mm
Çivi Uzunluğu	20-50 mm
Kartuş Kapasitesi	Çivi: 100 Adet Zimba: 100 Adet
Vuruş Hızı	60 adet/dk
Taşıma Çantası	<input checked="" type="checkbox"/>
Koli Adedi	2

ŞARJLI GRES TABANCASI



KLC240 (2.4 A)
Şarj Cihazı



KLC450 (4.5 A)
Şarj Cihazı



Bataryalar

KLGT18-00	Tek Makina	220 \$
KLGT18-20	2.0 Ah (2 x KLA1820 Batarya) (1 x 2.4 A Şarj Cihazı)	290 \$
KLGT18-50	5.0 Ah (2 x KLA1850 Batarya) (1 x 4.5 A Şarj Cihazı)	365 \$
KLGT18-80	8.0 Ah (2 x KLA1880 Batarya) (1 x 4.5 A Şarj Cihazı)	430 \$

İKİ VİTESLİ
BATARYA SEVİYESİNİ VE GRES SEVİYESİNİ
GÖSTEREN LCD EKREN
LED IŞIK



Led Işık



Voltaaj	Kartuş Kapasitesi
18 volt	400 gr.



Batarya Seviyesini
ve Gres Seviyesini
Gösteren LCD Ekran

KLGT18

Elektronik	<input checked="" type="checkbox"/>
Akü	18 V
Çıkış Basıncı	689 bar (10000 psi)
Besleme	Yüksek: 150 gr/dk Düşük: 100 gr/dk
Hortum Uzunluğu	1 metre
Kartuş Kapasitesi	400 gr
Tüp Kapasitesi	400 gr
Koli Adedi	4

ŞARJLI ÇAY TOPLAMA MAKİNASI



YENİ

KLCTM10B-10	10.0 Ah (1 x KLA2410 Batarya) (1 x 2.0 Ah Şarj Cihazı)	230 \$
KLCTM20B-20	20.0 Ah (1 x KLA2420 Batarya) (1 x 2.0 Ah Şarj Cihazı)	285 \$

Biçak Hızı	Akım Kapasitesi	Motor Devir Gücü	Çalışma Süresi
4800 dev/dk	20 Ah	0-13000 dev/dk	16 Saat

KÖMÜRSÜZ

KLCTM20B

Elektronik	<input checked="" type="checkbox"/>
Akü	10-20 V
Motor Gücü	400 W
Akım Kapasitesi	20 Ah
Yüksüz Akım	1.2 Ah
Biçak Hızı	4800 dev/dk
Motor Devir Gücü	0-13000 dev/dk
Çalışma Süresi	16 Saat
Şarj Süresi	10 Saat
Makine Ağırlığı	1.28 kg
Batarya Ağırlığı	3.6 kg
Batarya Sırt Çantası	<input checked="" type="checkbox"/>
Koli Adedi	1



KLA2410 Batarya 110 \$
10.0 Ah Batarya



KLA2420 Batarya 165 \$
20.0 Ah Batarya



Batarya Sırt Çantası



KLCTMC Şarj Cihazı 8 \$
2.0 Ah Şarj Cihazı



KLCTB Biçak 22 \$
Çay Kesme Biçağı

ŞARJLI ÇİM BİÇME MAKİNASI



**KLC240 (2.4 A)
Şarj Cihazı**



**KLC450 (4.5 A)
Şarj Cihazı**



Bataryalar

KLBLM36-00	Tek Makina	150 \$
KLBLM36-20	2.0 Ah (2 x KLA1820 Batarya) (1 x 2.4 A Şarj Cihazı)	220 \$
KLBLM36-50	5.0 Ah (2 x KLA1850 Batarya) (1 x 4.5 A Şarj Cihazı)	300 \$
KLBLM36-80	8.0 Ah (2 x KLA1880 Batarya) (1 x 4.5 A Şarj Cihazı)	360 \$

* 2 Adet 18 V Akü ile çalışır.



Yüksüz Hızı
3300 d/dk

Kesme Genişliği
340 mm

Ayarlanabilir Kesme Yüksekliği
30-80 mm

Çim Toplama Kapasitesi
35 lt

KLBLM36

Elektronik	<input checked="" type="checkbox"/>
Akü	36 V (2 x 18V)
Ayarlanabilir Kesme Yüksekliği	30-80 mm
Kesme Genişliği	340 mm
Çim Toplama Kapasitesi	35 lt
Yüksüz Hızı	3300 d/dk
Ağırlık	9.5 kg
Taşıma Çantası	<input type="checkbox"/>
Koli Adedi	1

ŞARJLI MİSİNALI ÇİM BİÇME MAKİNASI



**KLC240 (2.4 A)
Şarj Cihazı**



**KLC450 (4.5 A)
Şarj Cihazı**



Bataryalar

KLBMB18-00	Tek Makina	45 \$
KLBMB18-20	2.0 Ah (2 x KLA1820 Batarya) (1 x 2.4 A Şarj Cihazı)	115 \$
KLBMB18-50	5.0 Ah (2 x KLA1850 Batarya) (1 x 4.5 A Şarj Cihazı)	190 \$
KLBMB18-80	8.0 Ah (2 x KLA1880 Batarya) (1 x 4.5 A Şarj Cihazı)	255 \$



Yüksüz Hızı
8500 d/dk

Bıçaklı Kesme Kapasitesi
240 mm

Misinalı Kesme Kapasitesi
250 mm

Misina Ölçüleri
1.2 mm x 5 m

KLBMB18

Elektronik	<input checked="" type="checkbox"/>
Akü	18 V
Bıçaklı Kesme Kapasitesi	240 mm
Misinalı Kesme Kapasitesi	250 mm
Misina Ölçüleri	1.2 mm x 5 m
Yüksüz Hızı	8500 d/dk
Ağırlık	1.8 kg
Taşıma Çantası	<input type="checkbox"/>
Koli Adedi	2

ŞARJLI ZİNCİRLİ TESTERE



KLC240 (2.4 A)
Şarj Cihazı



KLC450 (4.5 A)
Şarj Cihazı



Bataryalar

KLBZT18-00	Tek Makina	85 \$
KLBZT18-20	2.0 Ah (2 x KLA1820 Batarya) (1 x 2.4 A Şarj Cihazı)	155 \$
KLBZT18-50	5.0 Ah (2 x KLA1850 Batarya) (1 x 4.5 A Şarj Cihazı)	230 \$
KLBZT18-80	8.0 Ah (2 x KLA1880 Batarya) (1 x 4.5 A Şarj Cihazı)	295 \$



Yüksüz Hızı



3200 d/dk

Pala Uzunluğu



110 mm

Zincir Hızı



4.7 m/s

KLBZT18

Elektronik	✓
Akü	18 V
Pala Uzunluğu	110 mm
Zincir Hızı	4.7 m/s
Yüksüz Hızı	3200 d/dk
Ağırlık	1.6 kg
Taşıma Çantası	—
Koli Adedi	2

ŞARJLI ORMAN MOTORLARI



KLC240 (2.4 A)
Şarj Cihazı



KLC450 (4.5 A)
Şarj Cihazı



Bataryalar

KLBOM18B-00	Tek Makina	115 \$
KLBOM18B-20	2.0 Ah (2 x KLA1820 Batarya) (1 x 2.4 A Şarj Cihazı)	185 \$
KLBOM18B-50	5.0 Ah (2 x KLA1850 Batarya) (1 x 4.5 A Şarj Cihazı)	260 \$
KLBOM18B-80	8.0 Ah (2 x KLA1880 Batarya) (1 x 4.5 A Şarj Cihazı)	325 \$



KÖMÜRSÜZ

Yüksüz Hızı



3600 d/dk

Zincir Palası



10"

Zincir Hızı



7 m/s

Yağ Tank Kapasitesi



100 ml

KLBOM18B

Elektronik	✓
Akü	18 V
Zincir Palası	10"
Zincir Hızı	7 m/s
Yağ Tank Kapasitesi	100 ml
Yüksüz Hızı	3600 d/dk
Ağırlık	2.9 kg
Taşıma Çantası	—
Koli Adedi	2



KLC240 (2.4 A)
Şarj Cihazı



KLC450 (4.5 A)
Şarj Cihazı



Bataryalar

KLBOM36B-00	Tek Makina	150 \$
KLBOM36B-20	2.0 Ah (2 x KLA1820 Batarya) (1 x 2.4 A Şarj Cihazı)	220 \$
KLBOM36B-50	5.0 Ah (2 x KLA1850 Batarya) (1 x 4.5 A Şarj Cihazı)	295 \$
KLBOM36B-80	8.0 Ah (2 x KLA1880 Batarya) (1 x 4.5 A Şarj Cihazı)	360 \$



KÖMÜRSÜZ

Yüksüz Hızı



7000 d/dk

Zincir Palası



14"

Zincir Hızı



13 m/s

Yağ Tank Kapasitesi



150 ml

KLBOM36B

Elektronik	✓
Akü	36 V (2 x 18V)
Zincir Palası	14"
Zincir Hızı	13 m/s
Yağ Tank Kapasitesi	150 ml
Yüksüz Hızı	7000 d/dk
Ağırlık	3.8 kg
Taşıma Çantası	—
Koli Adedi	2

* 2 Adet 18 V Akü ile çalışır.

ŞARJLI ÇİT BUDAMA MAKİNALARI



**KLC240 (2.4 A)
Şarj Cihazı**



**KLC450 (4.5 A)
Şarj Cihazı**



Bataryalar

KLBCB18-00	Tek Makina	45 \$
KLBCB18-20	2.0 Ah (2 x KLA1820 Batarya) (1 x 2.4 A Şarj Cihazı)	115 \$
KLBCB18-50	5.0 Ah (2 x KLA1850 Batarya) (1 x 4.5 A Şarj Cihazı)	190 \$
KLBCB18-80	8.0 Ah (2 x KLA1880 Batarya) (1 x 4.5 A Şarj Cihazı)	255 \$



Yüksüz Hızı	Çit Budama Bıçak Uzunluğu	Çit Kesme Kapasitesi	Çim Biçme Genişliği
1200 d/dk	199 mm	7.5 mm	92 mm

KLBCB18

Elektronik	<input checked="" type="checkbox"/>
Akü	18 V
Çit Budama Bıçak Uzunluğu	199 mm
Çit Kesme Kapasitesi	7.5 mm
Çim Biçme Genişliği	92 mm
Yüksüz Hızı	1200 d/dk
Ağırlık	1.6 kg
Taşıma Çantası	<input type="checkbox"/>
Koli Adedi	4



**KLC240 (2.4 A)
Şarj Cihazı**



**KLC450 (4.5 A)
Şarj Cihazı**



Bataryalar

KLBCBU18-00	Tek Makina	50 \$
KLBCBU18-20	2.0 Ah (2 x KLA1820 Batarya) (1 x 2.4 A Şarj Cihazı)	117 \$
KLBCBU18-50	5.0 Ah (2 x KLA1850 Batarya) (1 x 4.5 A Şarj Cihazı)	194 \$
KLBCBU18-80	8.0 Ah (2 x KLA1880 Batarya) (1 x 4.5 A Şarj Cihazı)	257 \$



Yüksüz Hızı	Bıçak Uzunluğu	Kesme Uzunluğu	Kesme Kapasitesi
1300 d/dk	580 mm	520 mm	15 mm

KLBCBU18

Elektronik	<input checked="" type="checkbox"/>
Akü	18 V
Bıçak Uzunluğu	580 mm
Kesme Uzunluğu	520 mm
Kesme Kapasitesi	15 mm
Yüksüz Hızı	1300 d/dk
Ağırlık	2.3 kg
Taşıma Çantası	<input type="checkbox"/>
Koli Adedi	2

ŞARJLI TİLKİ KUYRUĞU TESTERE (DAL KESME)



KLC240 (2.4 A)
Şarj Cihazı



KLC450 (4.5 A)
Şarj Cihazı



Bataryalar



Yüksüz Hızı



2200 d/dk

Derinlik Hareketi



14 mm

KLBTK18-00	Tek Makina	40 \$
KLBTK18-20	2.0 Ah (2 x KLA1820 Batarya) (1 x 2.4 A Şarj Cihazı)	110 \$
KLBTK18-50	5.0 Ah (2 x KLA1850 Batarya) (1 x 4.5 A Şarj Cihazı)	185 \$
KLBTK18-80	8.0 Ah (2 x KLA1880 Batarya) (1 x 4.5 A Şarj Cihazı)	250 \$

KLBTK18

Elektronik	<input checked="" type="checkbox"/>
Akü	18 V
Derinlik Hareketi	14 mm
Kesme Kapasitesi (Odun, Metal)	28 mm
Yüksüz Hızı	2200 d/dak
Ağırlık	1.1 kg
Taşıma Çantası	<input type="checkbox"/>
Koli Adedi	8

ŞARJLI BUDAMA MAKASI



KLC240 (2.4 A)
Şarj Cihazı



KLC450 (4.5 A)
Şarj Cihazı



Bataryalar



Kesim Kapasitesi



30 mm

KÖMÜRSÜZ

KLBBM18B-00	Tek Makina	110 \$
KLBBM18B-20	2.0 Ah (2 x KLA1820 Batarya) (1 x 2.4 A Şarj Cihazı)	177 \$
KLBBM18B-50	5.0 Ah (2 x KLA1850 Batarya) (1 x 4.5 A Şarj Cihazı)	254 \$
KLBBM18B-80	8.0 Ah (2 x KLA1880 Batarya) (1 x 4.5 A Şarj Cihazı)	317 \$

KLBBM18B

Elektronik	<input checked="" type="checkbox"/>
Akü	18 V
Kesme Kapasitesi	30 mm
Ağırlık	1.4 kg
Taşıma Çantası	<input type="checkbox"/>
Koli Adedi	4

ŞARJLI YAPRAK ÜFLEME MAKİNASI



**KLC240 (2.4 A)
Şarj Cihazı**



**KLC450 (4.5 A)
Şarj Cihazı**



Bataryalar



Hava Akış Hızı



36-108 km/s

Hava Akımı



114 - 336 m³/s

KLBUF18

Elektronik	✓
Akü	18 V
Hava Akış Hızı	36-108 km/s
Turbo	151 km/s
Hava Akımı	114 - 336 m³/s
Turbo	468 m³/s
Ağırlık	1.6 kg
Taşıma Çantası	—
Koli Adedi	1

KLBUF18-00	Tek Makina	55 \$
KLBUF18-20	2.0 Ah (2 x KLA1820 Batarya) (1 x 2.4 A Şarj Cihazı)	125 \$
KLBUF18-50	5.0 Ah (2 x KLA1850 Batarya) (1 x 4.5 A Şarj Cihazı)	200 \$
KLBUF18-80	8.0 Ah (2 x KLA1880 Batarya) (1 x 4.5 A Şarj Cihazı)	265 \$

ŞARJ CİHAZLARI



KLC200



KLC240



KLC450

Ürün Kodu	Voltaj	Çıkış Amperi	Liste Fiyatı
KLC200	10.8 V - 12 V	2.4 A	13,00 \$
KLC240	14.4 V - 18 V	2.4 A	16,00 \$
KLC450	14.4 V - 18 V	4.5 A	26,00 \$

AKÜ UZATMA APARATI



KLA18TA

16,00 \$

18 V Akü Uzatma Aparatı

* Makinanın toplam ağırlığını azaltarak uzun süreli kullanımlarda konfor sağlar.

LI-ION AKÜLER



KLA1020



KLA1820



KLA1850



KLA1880

Ürün Kodu	Voltaj	Akü Kapasitesi	Açıklama	Ağırlık	Liste Fiyatı
KLA1020	12 V	2.0 A	Akü	190 gr	19,00 \$
KLA1820	18.0 V	2.0 A	Akü	400 gr	31,00 \$
KLA1850	18.0 V	5.0 A	Akü	690 gr	64,00 \$
KLA1880	18.0 V	8.0 A	Akü	960 gr	95,00 \$

LAZER DİSTOMATLAR

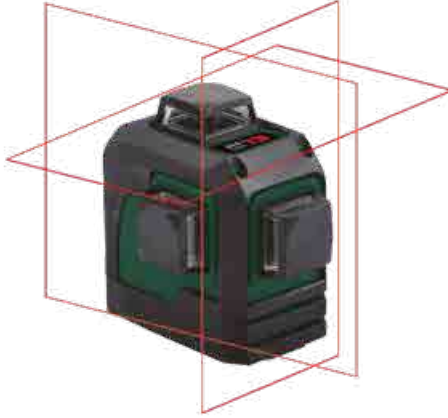

Hizalama Hassaslığı ± 0.4 mm/m	Oto. Hizalama Aralığı ± 3.5°	Lazer Tipi Kırmızı 635 nm
-----------------------------------	---------------------------------	---------------------------------

OTOMATİK HİZALAMA

KLLZR93

155 \$

Lazer Sınıfı	2 < 1mW
Hizalama Hassaslığı	± 0.4 mm / m
Işın Sayısı	3
Lazer Tipi	Kırmızı
Işın Yönü	Dikey / Yatay / Yan
İç Mekanda Görünürlük	15 m
Sehpa Bağlantısı	1/4"
Koli Adedi	4



Hizalama Hassaslığı ± 0.4 mm/m	Oto. Hizalama Aralığı ± 3.5°	Lazer Tipi Yeşil 515 nm
-----------------------------------	---------------------------------	-------------------------------

YEŞİL LAZER

2 ADET 7.4 VOLT BATARYA

OTOMATİK HİZALAMA

ŞARJLI & KABLOLU

KLLZR93GL

230 \$

Lazer Sınıfı	2 < 1mW
Hizalama Hassaslığı	± 0.4 mm / m
Işın Sayısı	3
Lazer Tipi	Yeşil
Işın Yönü	Dikey / Yatay / Yan
İç Mekanda Görünürlük	20 m
Sehpa Bağlantısı	1/4"
Batarya	7.4 V 2.6 Ah Li-Ion
Koli Adedi	4



Hizalama Hassaslığı ± 0.4 mm/m	Oto. Hizalama Aralığı ± 3°	Lazer Tipi Kırmızı 635 nm
-----------------------------------	-------------------------------	---------------------------------

OTOMATİK HİZALAMA

KLLZR232

180 \$

Lazer Sınıfı	2 < 1mW
Hizalama Hassaslığı	± 0.4 mm / m
Işın / Nokta Sayısı	2 / 5
Lazer Tipi	Kırmızı
Işın Yönü	Dikey / Yatay
İç Mekanda Görünürlük	10 m
Sehpa Bağlantısı	1/4" - 5/8"
Koli Adedi	4



Hizalama Hassaslığı ± 0.4 mm/m	Oto. Hizalama Aralığı ± 3.5°	Lazer Tipi Yeşil 515 nm
-----------------------------------	---------------------------------	-------------------------------

YEŞİL LAZER

OTOMATİK HİZALAMA

KLLZR233GL

125 \$

Lazer Sınıfı	2 < 1mW
Hizalama Hassaslığı	± 0.4 mm / m
Nokta Sayısı	5
Lazer Tipi	Yeşil
Işın Yönü	Dikey / Yatay
İç Mekanda Görünürlük	30 m
Sehpa Bağlantısı	1/4"
Koli Adedi	20

LAZER DİSTOMATLAR



Hizalama Hassaslığı ± 0.4 mm/m	Oto. Hizalama Aralığı ± 3°	Lazer Tipi Kırmızı 635 nm
-----------------------------------	-------------------------------	---------------------------------

OTOMATİK HİZALAMA

KLLZR112

50 \$

Lazer Sınıfı	2 < 1mW
Hizalama Hassaslığı	± 0.4 mm / m
Işın Sayısı	2
Lazer Tipi	Kırmızı
Işın Yönü	Dikey / Yatay
İç Mekanda Görünürlük	10 m
Sehpa Bağlantısı	1/4"
Koli Adedi	20



Hizalama Hassaslığı ± 0.4 mm/m	Oto. Hizalama Aralığı ± 3°	Lazer Tipi Yeşil 515 nm
-----------------------------------	-------------------------------	-------------------------------

OTOMATİK HİZALAMA

YEŞİL LAZER

KLLZR112GL

70 \$

Lazer Sınıfı	2 < 1mW
Hizalama Hassaslığı	± 0.4 mm / m
Işın Sayısı	2
Lazer Tipi	Yeşil
Işın Yönü	Dikey / Yatay
İç Mekanda Görünürlük	15 m
Sehpa Bağlantısı	1/4"
Koli Adedi	20



Hizalama Hassaslığı ± 0.4 mm/m	Oto. Hizalama Aralığı ± 3°	Lazer Tipi Kırmızı 635 nm
-----------------------------------	-------------------------------	---------------------------------

OTOMATİK HİZALAMA

KLLZR118

100 \$

Lazer Sınıfı	2 < 1mW
Hizalama Hassaslığı	± 0.4 mm / m
Işın Sayısı	2
Lazer Tipi	Kırmızı
Işın Yönü	Dikey / Yatay
İç Mekanda Görünürlük	15 m
Sehpa Bağlantısı	1/4"
Koli Adedi	5



Hizalama Hassaslığı ± 0.4 mm/m	Oto. Hizalama Aralığı ± 3.5°	Lazer Tipi Yeşil 515 nm
-----------------------------------	---------------------------------	-------------------------------

YEŞİL LAZER

OTOMATİK HİZALAMA

KLLZR118GL

145 \$

Lazer Sınıfı	2 < 1mW
Hizalama Hassaslığı	± 0.4 mm / m
Işın Sayısı	2
Lazer Tipi	Yeşil
Işın Yönü	Dikey / Yatay
İç Mekanda Görünürlük	20 m
Sehpa Bağlantısı	1/4"
Koli Adedi	5

OPTİK NİVO



5 METRE MİRA
MAKSİMUM 100 METRE
ÖLÇÜM



KLON3200

240 \$

Büyütme Oranı	32X
1 km İçin Standart Sapma	1.0 mm
Hassasiyet	± 0.3"
Hizalama Çalışma Menzili	± 1.5'
Objektif Çapı	36 mm
Görüş Alanı	1°20'
Görüntü	Dik
Koli Adedi	4

LAZER DİSTOMAT AKSESUARLARI



LAZER ÇİZGİ İZLEME GÖZLÜKLERİ

Parça Kodu	Açıklama	Fiyatı
KLLZKG15	Kırmızı Lazer Çizgi İzleme Gözlüğü	7,00 \$
KLLZYG25	Yeşil Lazer Çizgi İzleme Gözlüğü	9,00 \$



HEDEF LEVHALARI

Parça Kodu	Açıklama	Fiyatı
KLLZHK7	Kırmızı Hedef Levhası	4,00 \$
KLLZHY8	Yeşil Hedef Levhası	6,00 \$



MIKNATISLI DİSTOMAT AYAKLARI

Parça Kodu	Açıklama	Fiyatı
KLLZMDAY20	Mıknatıslı Ayarlanabilir Distomat Ayağı	30,00 \$
KLLZMDA12	Mıknatıslı Distomat Ayağı	22,00 \$



DİSTOMAT ASKI APARATLARI

Parça Kodu	Açıklama	Fiyatı
KLLZAY8	Ayarlanabilir Askı Aparatı	11,00 \$
KLLZA5	Askı Aparatı	9,00 \$

LAZER MESAFE ÖLÇERLER

Ölçme Hassasiyeti



± 2 mm

Lazer Sınıfı

635 nm,
2 <1 mW

Ölçü Değeri Kaydetme



30 Birim

KLZM50**45 \$**

Lazer Sınıfı	635 nm , 2<1 mW
Ölçme Hassasiyeti	± 2 mm
Ölçme Mesafesi	50 m
Pil	2 x 1.5 V AAA
Koli Adedi	10

/// ALAN ÖLÇÜMÜ**/// HACİM ÖLÇÜMÜ****/// PİSAGOR ÖLÇÜM FONKSİYONU**

Ölçme Hassasiyeti



± 1.5 mm

Lazer Sınıfı

635 nm,
2 <1 mW

Ölçü Değeri Kaydetme



100 Birim

KLZM100**80 \$**

Lazer Sınıfı	635 nm , 2<1 mW
Ölçme Hassasiyeti	± 1.5 mm
Ölçme Mesafesi	100 m
Pil	2 x 1.5 V AAA
Koli Adedi	10

/// ALAN ÖLÇÜMÜ**/// HACİM ÖLÇÜMÜ****/// PİSAGOR ÖLÇÜM FONKSİYONU**

Ölçme Hassasiyeti



± 1.5 mm

Lazer Sınıfı

635 nm,
2 <1 mW

Ölçü Değeri Kaydetme



100 Birim

KLZM120B**235 \$**

Lazer Sınıfı	635 nm , 2<1 mW
Ölçme Hassasiyeti	± 1.5 mm
Ölçme Mesafesi	120 m
Pil	3 x 1.2 V AAA
Koli Adedi	25

/// BLUETOOTH**/// KAMERA****/// RENKLİ EKРАН****/// USB GİRİŞİ****/// ELEKTRONİK AÇI ÖLÇME****TRİPOD****/// PROFESYONEL****/// HAFİF****/// VIDALI AYAK SİSTEMİ****/// DIŞLI ASANSÖR SİSTEMİ****/// 3 BÖLÜMLÜ AYAK****KLZT****35 \$**

Sehpa Bağlantısı	1/4"
Kapalı Boyu	60 cm
Açık Boyu	150 cm
Koli Adedi	10

DARBESİZ MATKAPLAR



KLNM61210

35 \$

Elektronik / Sağ-Sol	✓ / ✓
Güçü	500 W
Yüksüz Hızı	0-3500 dev/dk
Mandren Kapasitesi	10 mm
Ağırlık	1.2 kg
Koli Adedi	10



KLNM1002

42 \$

Elektronik / Sağ-Sol	✓ / ✓
Güçü	600 W
Yüksüz Hızı	0-3500 dev/dk
Mandren Kapasitesi	10 mm
Ağırlık	1.5 kg
Koli Adedi	10

ALÇIPAN VIDALAMA



KLAV60266

60 \$

Elektronik / Sağ-Sol	✓ / ✓
Güçü	500 W
Yüksüz Hızı	0-2050 dev/dk
Maksimum Vida Çapı	6 mm HEX
Ağırlık	2.2 kg
Koli Adedi	6

DARBELİ MATKAPLAR



Güçü	Yüksüz Hızı	Mandren Kapasitesi
W		
650 W	0-3100 dev/dk	13 mm

ANAHTARSIZ MANDREN

KLDM1106

35 \$

Elektronik / Sağ-Sol	<input checked="" type="checkbox"/> / <input checked="" type="checkbox"/>
Güçü	650 W
Yüksüz Hızı	0-3100 dev/dk
Mandren Kapasitesi	13 mm
Ağırlık	3.5 kg
Koli Adedi	10



Güçü	Yüksüz Hızı	Mandren Kapasitesi
W		
800 W	0-2800 dev/dk	13 mm

ANAHTARSIZ METAL MANDREN

KLDM1305

55 \$

Elektronik / Sağ-Sol	<input checked="" type="checkbox"/> / <input checked="" type="checkbox"/>
Güçü	800 W
Yüksüz Hızı	0-2800 dev/dk
Mandren Kapasitesi	13 mm
Ağırlık	1.9 kg
Koli Adedi	10



Güçü	Yüksüz Hızı	Mandren Kapasitesi
W		
1200 W	0-1000 / 0-2800 dev/dk	13 mm

2 KADEMELİ VİTES

ANAHTARSIZ METAL MANDREN

ALÜMİNYUM DIŞLI KUTUSU

KLDM71220

90 \$

Elektronik / Sağ-Sol	<input checked="" type="checkbox"/> / <input checked="" type="checkbox"/>
Güçü	1200 W
Yüksüz Hızı	0-1000 / 0-2800 dev/dk
Mandren Kapasitesi	13 mm
Taşıma Çantası	<input checked="" type="checkbox"/>
Ağırlık	3 kg
Koli Adedi	4

ELEKTRİKLİ SOMUN SIKMA/SÖKME



Güçü	Yüksüz Hızı	Maksimum Tork
W		
900 W	2400 dev/dk	320 Nm
Maksimum Somun Çapı	Uç Kovanı	Ağırlık
M22	1/2"	3.4 kg

KLSS1901

90 \$

Elektronik / Sağ-Sol	<input type="checkbox"/> / <input checked="" type="checkbox"/>
Güçü	900 W
Yüksüz Hızı	2400 dev/dk
Maksimum Tork	320 Nm
Maksimum Somun Çapı	M22
Uç Kovanı	1/2 "
Ağırlık	3.4 kg
Koli Adedi	5

PNÖMATİK MATKAPLAR (SDS-PLUS)



Aksesuar
3 adet uç

Güçü	Yüksüz Hızı	Darbe Oranı
850 W	0-1100 dev/dk	0-4200 dar/dk
Betonda Delme Kapasitesi	Darbe Gücü	
26 mm	3.2 J	

KLPM2601

100 \$

Elektronik / Sağ-Sol	✓ / ✓
Güçü	850 W
Yüksüz Hızı	0-1100 dev/dk
Darbe Oranı	0-4200 dar/dk
Darbe Gücü	3.2 J
Betonda Delme Kapasitesi	26 mm
Taşıma Çantası	✓
Ağırlık	3.3 kg
Koli Adedi	4



Aksesuar
3 adet uç

Güçü	Yüksüz Hızı	Darbe Oranı
950 W	0-1300 dev/dk	0-5000 dar/dk
Uç Tutucu	Betonda Delme Kapasitesi	Darbe Gücü
SDS PLUS	28 mm	4.0 J

DEĞİŞTİRİLEBİLİR
MANDREN SİSTEMİ

KLPM2801

140 \$

Elektronik / Sağ-Sol	✓ / ✓
Güçü	950 W
Yüksüz Hızı	0-1300 dev/dk
Darbe Oranı	0-5000 dar/dk
Darbe Gücü	4.0 J
Betonda Delme Kapasitesi	28 mm
Taşıma Çantası	✓
Ağırlık	3.6 kg
Koli Adedi	4



KIRICI/DELİCİLER



Güçü W 1100 W	Betonda Delme Kapasitesi mm 32 mm	Darbe Gücü J 6 J
Uç Tutucu SDS PLUS	Tutma Kolu AVC Aktif Titreşim Kontrolü	Ağırlık KG 5.6 kg

KÖMÜR İKAZ İŞİĞİ

KLKD580P

240 \$

Elektronik / Sağ-Sol	✓ / -
Güçü	1100 W
Yüksüz Hızı	300-760 dev/dk
Darbe Oranı	1900-4800 dar/dk
Darbe Gücü	6 J
Betonda Delme Kapasitesi	32 mm
Salınımlı Tutma Kolu	✓
Uç Tutucu	SDS PLUS
Ağırlık	5.6 kg
Taşıma Çantası	✓
Koli Adedi	1



Güçü W 1100 W	Betonda Delme Kapasitesi mm 35 mm	Darbe Gücü J 7 J
Uç Tutucu SDS MAX	Tutma Kolu AVC Aktif Titreşim Kontrolü	Ağırlık KG 5.8 kg

KÖMÜR İKAZ İŞİĞİ

KLKD610M

275 \$

Elektronik / Sağ-Sol	✓ / -
Güçü	1100 W
Yüksüz Hızı	300-760 dev/dk
Darbe Oranı	1950-4860 dar/dk
Darbe Gücü	7 J
Betonda Delme Kapasitesi	35 mm
Salınımlı Tutma Kolu	✓
Uç Tutucu	SDS MAX
Ağırlık	5.8 kg
Taşıma Çantası	✓
Koli Adedi	1



Güçü W 1200 W	Betonda Delme Kapasitesi mm 42 mm	Darbe Gücü J 10 J
Uç Tutucu SDS MAX	Tutma Kolu AVC Aktif Titreşim Kontrolü	Ağırlık KG 6.6 kg

KÖMÜR İKAZ İŞİĞİ

KLKD660M

390 \$

Elektronik / Sağ-Sol	✓ / -
Güçü	1200 W
Yüksüz Hızı	235-514 dev/dk
Darbe Oranı	1350-2950 dar/dk
Darbe Gücü	10 J
Betonda Delme Kapasitesi	42 mm
Salınımlı Tutma Kolu	✓
Uç Tutucu	SDS MAX
Ağırlık	6.6 kg
Taşıma Çantası	✓
Koli Adedi	1



Güçü W 1500 W	Betonda Delme Kapasitesi mm 52 mm	Darbe Gücü J 15 J
Uç Tutucu SDS MAX	Tutma Kolu AVC Aktif Titreşim Kontrolü	Ağırlık KG 8.9 kg

KÖMÜR İKAZ İŞİĞİ

KLKD890M

550 \$

Elektronik / Sağ-Sol	✓ / -
Güçü	1500 W
Yüksüz Hızı	150-305 dev/dk
Darbe Oranı	1380-2760 dar/dk
Darbe Gücü	15 J
Betonda Delme Kapasitesi	52 mm
Salınımlı Tutma Kolu	✓
Uç Tutucu	SDS MAX
Ağırlık	8.9 kg
Taşıma Çantası	✓
Koli Adedi	1

KIRICILAR



Güçü W 1500 W	Darbe Oranı 1000-1900 dar/dk	Darbe Gücü 25 J
Uç Tutucu SDS MAX	Tutma Kolu Aktif Titreşim Kontrolü	Ağırlık 10.5 kg

KÖMÜR İKAZ İŞİĞİ

Aksesuar
1 adet murç
1 adet keski

KLKR1100M

430 \$

Elektronik	✓
Güçü	1500 W
Darbe Oranı	1000-1900 dar/dk
Darbe Gücü	25 J
Uç Tutucu	SDS MAX
Salınımlı Tutma Kolu	✓
Ağırlık	10.5 kg
Taşıma Çantası	✓
Koli Adedi	1



Güçü W 1700 W	Darbe Oranı 1450 dar/dk	Darbe Gücü 55 J
Uç Tutucu 28 mm HEX	Tutma Kolu Aktif Titreşim Kontrolü	Ağırlık 19 kg

Aksesuar
1 adet murç
1 adet keski





KLKR1800H

580 \$

Elektronik	✓
Güçü	1700 W
Darbe Oranı	1450 dar/dk
Darbe Gücü	55 J
Uç Tutucu	28mm HEX
Salınımlı Tutma Kolu	✓
Ağırlık	19 kg
Taşıma Çantası	✓
Koli Adedi	1



KIRICILAR

Güçü	Darbe Oranı	Darbe Gücü
		
2200 W	950 dar/dk	78 J
Uç Tutucu	Tutma Kolu	Ağırlık
		
28 mm HEX	Aktif Titreşim Kontrolü	34.5 kg

Aksesuar
1 adet murç
1 adet keski
1 adet taşıma arabası

KLKR3200H**920 \$**

Elektronik	✓
Güçü	2200 W
Darbe Oranı	950 dar/dk
Darbe Gücü	78 J
Uç Tutucu	28 mm HEX
Salınımlı Tutma Kolu	✓
Ağırlık	34.5 kg
Taşıma Arabası	✓
Koli Adedi	1

TAŞIMA ARABASI

- /// UÇ TAŞIMA CEBİ
- /// SABİTLEYİCİ KANCA

KLKR32TA**90 \$**

Kapasite	136 kg
Genişlik	50 cm
Yükseklik	110 cm
Ağırlık	12.6 kg



AVUÇ TAŞLAMALAR



Güçü	Yüksüz Hızı	Disk Çapı
W		
750 W	11000 dev/dk	115 mm

- /// GÜVENLİKLİ TETİK
- /// YUMUŞAK TUTMA KOLU
- /// YUMUŞAK BAŞLANGIÇ

KLAT11502

42 \$

Yumuşak Başlangıç	<input type="checkbox"/>
Güçü	750 W
Yüksüz Hızı	11000 dev/dk
Disk Çapı	115 mm
Ağırlık	1.5 kg
Koli Adedi	10



Güçü	Yüksüz Hızı	Disk Çapı
W		
850 W	11000 dev/dk	115 mm

- /// GÜVENLİKLİ TETİK
- /// YUMUŞAK TUTMA KOLU
- /// YUMUŞAK BAŞLANGIÇ

KLAT11505

50 \$

Yumuşak Başlangıç	<input type="checkbox"/>
Güçü	850 W
Yüksüz Hızı	11000 dev/dk
Disk Çapı	115 mm
Ağırlık	2.2 kg
Koli Adedi	10



Güçü	Yüksüz Hızı	Disk Çapı
W		
1100 W	11500 dev/dk	125 mm

- /// GÜVENLİKLİ TETİK
- /// YUMUŞAK TUTMA KOLU
- /// YUMUŞAK BAŞLANGIÇ

KLAT11507

55 \$

Yumuşak Başlangıç	<input type="checkbox"/>
Güçü	1100 W
Yüksüz Hızı	11500 dev/dk
Disk Çapı	125 mm
Ağırlık	2.1 kg
Koli Adedi	8



Güçü	Yüksüz Hızı	Disk Çapı
W		
1100 W	3000-11000 dev/dk	125 mm

- /// ELEKTRONİK DEVİR AYARI
- /// TİTREŞİM EMİCİ KOL

KLAT11511

60 \$

Yumuşak Başlangıç	<input type="checkbox"/>
Güçü	1100 W
Yüksüz Hızı	3000-11000 dev/dk
Disk Çapı	125 mm
Ağırlık	3.2 kg
Koli Adedi	8



Güçü	Yüksüz Hızı	Disk Çapı
W		
900 W	0-11000 dev/dk	115 mm

- /// ALTAN TETİK
- /// TİTREŞİM EMİCİ KOL

KLAT11510

52 \$

Yumuşak Başlangıç	<input checked="" type="checkbox"/>
Güçü	900 W
Yüksüz Hızı	0-11000 dev/dk
Disk Çapı	115 mm
Ağırlık	1.7 kg
Koli Adedi	4

AVUÇ TAŞLAMALAR

YENİ



Güçü	Yüksüz Hızı	Disk Çapı
W		
1800 W	11000 dev/dk	125 mm

- /// GÜVENLİKLİ TETİK**
- /// TİTREŞİM EMİCİ KOL**
- /// YUMUŞAK BAŞLANGIÇ**

KLAT11517

90 \$

Yumuşak Başlangıç	<input checked="" type="checkbox"/>
Güçü	1800 W
Yüksüz Hızı	11000 dev/dk
Disk Çapı	125 mm
Ağırlık	2.5 kg
Koli Adedi	6

YENİ



Güçü	Yüksüz Hızı	Disk Çapı
W		
1800 W	3000-11000 dev/dk	125 mm

- /// ELEKTRONİK DEVİR AYARI**
- /// GÜVENLİKLİ TETİK**
- /// TİTREŞİM EMİCİ KOL**
- /// YUMUŞAK BAŞLANGIÇ**

KLAT11518

100 \$

Yumuşak Başlangıç	<input checked="" type="checkbox"/>
Güçü	1800 W
Yüksüz Hızı	3000-11000 dev/dk
Disk Çapı	125 mm
Ağırlık	2.5 kg
Koli Adedi	6

YENİ



KÖMÜRSÜZ

Güçü	Yüksüz Hızı	Disk Çapı
W		
1550 W	9500 dev/dk	125 mm

- /// GÜVENLİKLİ TETİK**
- /// TİTREŞİM EMİCİ KOL**
- /// YUMUŞAK BAŞLANGIÇ**

KLAT12506B

150 \$

Yumuşak Başlangıç	<input checked="" type="checkbox"/>
Güçü	1550 W
Yüksüz Hızı	9500 dev/dk
Disk Çapı	125 mm
Ağırlık	1.8 kg
Koli Adedi	8

YENİ



KÖMÜRSÜZ

Güçü	Yüksüz Hızı	Disk Çapı
W		
1550 W	2800-9500 dev/dk	125 mm

- /// ELEKTRONİK DEVİR AYARI**
- /// GÜVENLİKLİ TETİK**
- /// TİTREŞİM EMİCİ KOL**
- /// YUMUŞAK BAŞLANGIÇ**

KLAT12509B

165 \$

Yumuşak Başlangıç	<input checked="" type="checkbox"/>
Güçü	1550 W
Yüksüz Hızı	2800-9500 dev/dk
Disk Çapı	125 mm
Ağırlık	1.8 kg
Koli Adedi	8

BÜYÜK TAŞLAMALAR



Güçü	Yüksüz Hızı	Disk Çapı
W		
2200 W	8000 dev/dk	180 mm

YUMUŞAK BAŞLANGIÇ

TİTREŞİM EMİCİ KOL

KLBT83180

100 \$

Yumuşak Başlangıç	<input checked="" type="checkbox"/>
Güçü	2200 W
Yüksüz Hızı	8000 dev/dk
Disk Çapı	180 mm
Ağırlık	5 kg
Koli Adedi	2



Güçü	Yüksüz Hızı	Disk Çapı
W		
2200 W	6500 dev/dk	230 mm

YUMUŞAK BAŞLANGIÇ

TİTREŞİM EMİCİ KOL

KLBT83230

100 \$

Yumuşak Başlangıç	<input checked="" type="checkbox"/>
Güçü	2200 W
Yüksüz Hızı	6500 dev/dk
Disk Çapı	230 mm
Ağırlık	5.2 kg
Koli Adedi	2



Güçü	Yüksüz Hızı	Disk Çapı
W		
2600 W	8000 dev/dk	180 mm

YUMUŞAK BAŞLANGIÇ

DÖNEBİLİR TUTMA SAPI

TİTREŞİM EMİCİ KOL

KLBT87180

120 \$

Yumuşak Başlangıç	<input checked="" type="checkbox"/>
Güçü	2600 W
Yüksüz Hızı	8000 dev/dk
Disk Çapı	180 mm
Ağırlık	6.1 kg
Koli Adedi	4



Güçü	Yüksüz Hızı	Disk Çapı
W		
2600 W	6500 dev/dk	230 mm

YUMUŞAK BAŞLANGIÇ

DÖNEBİLİR TUTMA SAPI

TİTREŞİM EMİCİ KOL

KLBT87230

120 \$

Yumuşak Başlangıç	<input checked="" type="checkbox"/>
Güçü	2600 W
Yüksüz Hızı	6500 dev/dk
Disk Çapı	230 mm
Ağırlık	6.2 kg
Koli Adedi	4

KALIPÇI TAŞLAMALAR**KLKT505****50 \$**

Güçü	450 W
Yüksüz Hızı	27000 dev/dk
Boy	Kısa
Maksimum Pens Çapı	6 mm
Ağırlık	1.4 kg
Koli Adedi	10

**KLKT507****60 \$**

Güçü	450 W
Yüksüz Hızı	27000 dev/dk
Boy	Uzun
Maksimum Pens Çapı	6 mm
Ağırlık	1.7 kg
Koli Adedi	10

ALÇIPAN ZIMPARA MAKİNASI**KLDZ8821****200 \$**

Elektronik	✓
Güçü	880 W
Yüksüz Hızı	1000-2100 dev/dk
Boru Çapı	35 mm
Zımpara Tablasının Çapı	215 mm
Zımpara Kağıdının Çapı	225 mm
Normal/Uzun	171/226 cm
Aksesuar	✓
Ağırlık	4.1 kg
Koli Adedi	1

- LED IŞIK
- DAHİLİ TOZ EMME SİSTEMİ
- 5 KADEMELİ HIZ AYARI
- AYARLANABİLİR TELESKOPIK TUTMA SAPI

Aksesuar
6 adet zımpara kağıdı, 1 adet bez çanta,

POLİSAJ MAKİNALARI



Aksesuar
Yün keçe ve taban



DEVİR AYARLI

KLPJ42180

85 \$

Elektronik	<input checked="" type="checkbox"/>
Güçü	1400 W
Yüksüz Hızı	1000-3300 dev/dk
Disk Çapı	180 mm / 230 mm
Mil Bağlantı Dişi	M14
Ağırlık	3.3 kg
Koli Adedi	4



Aksesuar
150 mm sünger



ORBİTAL DÖNÜŞ

DEVİR AYARLI

KLPJ7171

135 \$

Elektronik	<input checked="" type="checkbox"/>
Güçü	720 W
Yüksüz Hızı	2100-5000 dev/dk
Disk Çapı	150 mm
Eksantrik Mesafesi	21 mm
Mil Bağlantı Dişi	M14
Ağırlık	2.6 kg
Koli Adedi	4

PROFİL KESMELER



Aksesuar
1 adet bıçak



KLPK2506

195 \$

Yumuşak Başlangıç	<input type="checkbox"/>
Güçü	2500 W
Yüksüz Hızı	3800 dev/dk
Disk Çapı	355x25.4 mm
Mil Kilidi	<input checked="" type="checkbox"/>
Ağırlık	15.2 kg
Koli Adedi	1



Aksesuar
1 adet bıçak



KLPK3006

250 \$

Yumuşak Başlangıç	<input type="checkbox"/>
Güçü	3000 W
Yüksüz Hızı	3800 dev/dk
Disk Çapı	355x25.4 mm
Mil Kilidi	<input checked="" type="checkbox"/>
Ağırlık	16.8 kg
Koli Adedi	1

DUVAR KANAL AÇMA MAKİNASI



Aksesuar
35 mm bıçak



KLKA1002

390 \$

Güçü	1450 W
Yüksüz Hızı	1800 dev/dk
Maks. Oluk Açma Derinliği	35 mm
Maks. Oluk Açma Genişliği	35 mm
Taşıma Çantası	✓
Ağırlık	7 kg
Koli Adedi	2

ÇOK AMAÇLI MAKİNA



5 PARÇA AKSESUAR SETİ

KLMT305

57 \$

Güçü	300 W
Dakikada Titreşim Sayısı	15000-22000 tit/dk
Titreşim Açısı	3°
Aksesuar	✓
Taşıma Çantası	✓
Ağırlık	1.5 kg
Koli Adedi	6

TAŞ MOTORLARI



Aksesuar
2 adet zımpara taşı

KLTM150

65 \$

Güçü	250 W
Voltaj	230 V / 50 Hz
Yüksüz Hızı	2950 dev/dk
Taş Çapı	150x20x20mm
Ağırlık	8.2 kg
Koli Adedi	1



Aksesuar
2 adet zımpara taşı

KLTM175

75 \$

Güçü	400 W
Voltaj	230 V / 50 Hz
Yüksüz Hızı	2950 dev/dk
Taş Çapı	175x20x20mm
Ağırlık	9.5 kg
Koli Adedi	1



Aksesuar
2 adet zımpara taşı

KLTM200

80 \$

Güçü	400 W
Voltaj	230 V / 50 Hz
Yüksüz Hızı	2950 dev/dk
Taş Çapı	200x20x20mm
Ağırlık	11.5 kg
Koli Adedi	1

DEKUPAJ TESTERELER



- PANDÜL HAREKETİ
- DEVİR AYARLI

KLDT10265

55 \$

Elektronik	✓
Güçü	450 W
Yüksüz Hızı	500-3100 dev/dk
Kesme Kapasitesi Ahşap/Metal	60/6 mm
Pandül Hareketi	✓
Ağırlık	2.0 kg
Koli Adedi	10

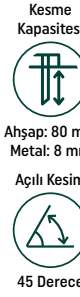

- LAZER KESİM ÇİZGİSİ
- PANDÜL HAREKETİ
- DEVİR AYARLI
- HIZLI BIÇAK DEĞİŞTİRME SİSTEMİ

KLDT1110

85 \$

Elektronik	✓
Güçü	710 W
Yüksüz Hızı	0-3000 dev/dk
Kesme Kapasitesi Ahşap/Metal	80/8 mm
45° Açılı Kesim	✓
Pandül Hareketi	✓
Ağırlık	3.1 kg
Koli Adedi	10

TİLKİ KUYRUĞU TESTERELER



Aksesuar
Biçak



- HIZLI BIÇAK DEĞİŞTİRME SİSTEMİ
- DÖNEBİLİR TUTMA SAPI

KLTK0850

60 \$

Elektronik	✓
Güçü	850 W
Yüksüz Hızı	0-2800 dev/dk
Derinlik Hareketi	25 mm
Ağırlık	3.0 kg
Koli Adedi	4



Aksesuar
Biçak



- HIZLI BIÇAK DEĞİŞTİRME SİSTEMİ
- DÖNEBİLİR TUTMA SAPI

KLTK1100

90 \$

Elektronik	✓
Güçü	1100 W
Yüksüz Hızı	0-2800 dev/dk
Derinlik Hareketi	28 mm
Ağırlık	3.4 kg
Koli Adedi	4

DAİRE TESTERELER

1350 W



5000 dev/dk



65 mm



185 x 20 mm



45 mm

KLDAT18501**100 \$**

Gücü	1350 W
Yüksüz Hızı	5000 dev/dk
Bıçak Çapı	185 x 20 mm
90° Kesim Derinliği	65 mm
45° Kesim Derinliği	45 mm
Ağırlık	5,1 kg
Koli Adedi	4



2400 W



3650 dev/dk



85 mm



235x25.4 mm



52 mm

KLDAT96235**145 \$**

Gücü	2400 W
Yüksüz Hızı	3650 dev/dk
Bıçak Çapı	235 x 25.4 mm
90° Kesim Derinliği	85 mm
45° Kesim Derinliği	52 mm
Ağırlık	71 kg
Koli Adedi	2

SERAMİK KESME MAKİNASI

1200 W



12000 dev/dk



22 mm



110x20 mm



32 mm

KLSK2202**70 \$**

Gücü	1200 W
Yüksüz Hızı	12000 dev/dk
45° Kesim Derinliği	22 mm
90° Kesim Derinliği	32 mm
Disk Çapı	110x20 mm
Ağırlık	3,0 kg
Koli Adedi	4

SULU KESİM**PLANYA**Aksesuar
82 mm bıçak

850 W



16500 dev/dk



82 mm



3.4 kg



0-3 mm

KLPL1011**85 \$**

Gücü	850 W
Yüksüz Hızı	16500 dev/dk
Maksimum Derinlik	0-3 mm
Lamba Derinliği	0-15 mm
Planya Genişliği	82 mm
Ağırlık	3,4 kg
Koli Adedi	2



EL FREZESİ



Aksesuar
12 mm pens

Güçü W 1800 W	Yüksüz Hızı 9000-23000 dev/dk	Uç Girişi 6-8-12 mm Derinlik Hareketi 0-60 mm
----------------------------	--------------------------------------	--

DEVİR AYARLI

KLEF1205

135 \$

Elektronik	<input checked="" type="checkbox"/>
Güçü	1800 W
Yüksüz Hızı	9000-23000 dev/dk
Derinlik Hareketi	0-60 mm
Uç Girişi	6-8-12 mm
Ağırlık	6.25 kg
Koli Adedi	4

FORMİKA TRAŞLAMA MAKİNASI



Aksesuar
6 mm pens

Güçü W 710 W	Yüksüz Hızı 35000 dev/dk	Uç Girişi 6 mm Derinlik Hareketi 0-40 mm
---------------------------	---------------------------------	---

KLFT1021

45 \$

Elektronik	<input checked="" type="checkbox"/>
Güçü	710 W
Yüksüz Hızı	35000 dev/dk
Derinlik Hareketi	0-40 mm
Uç Girişi	6 mm
Ağırlık	1.5 kg
Koli Adedi	4

ÜFLEME MAKİNASI



Güçü W 500 W	Yüksüz Hızı 16000 dev/dk
---------------------------	---------------------------------

KLUF903

45 \$

Güçü	500 W
Yüksüz Hızı	16000 dev/dk
Toz Torbası	<input checked="" type="checkbox"/>
Üfleme / Emme	<input checked="" type="checkbox"/>
Ağırlık	1.65 kg
Koli Adedi	6

SICAK HAVA TABANCASI



5 PARÇA AKSESUAR SETİ



KL SH7303

35 \$

Güçü	2000 W
Hava Akımı 1.Kademe	250 lt/dk
Hava Akımı 2.Kademe	500 lt/dk
Sıcaklık 1.Kademe	50-450 °C
Sıcaklık 2.Kademe	60-650 °C
Isı Ayarı	✓
Yüksek Isı Koruması	✓
Aksesuar	✓
Ağırlık	0,93 kg
Koli Adedi	5

TİTREŞİMLİ VE EKSANTRİK ZİMPARALAR

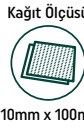

Aksesuar
1 adet zımpara kağıdı

KLEZ43110

45 \$

Güçü	150 W
Dakikada Titreşim Sayısı	12000 tit/dk
Yörünge Çapı	1,1 mm
Kağıt Ölçüsü	110 mm x 100 mm
Ağırlık	1,3 Kg
Koli Adedi	20

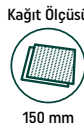

DEVİR AYARLI

KLEZ43150

55 \$

Elektronik	✓
Güçü	450 W
Yüksüz Hızı	6000-12000 dev/dk
Kağıt Ölçüsü	150 mm
Ağırlık	1,9 Kg
Koli Adedi	4

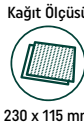

Aksesuar
1 adet zımpara kağıdı

DEVİR AYARLI

KLEZ35230

50 \$

Elektronik	✓
Güçü	350 W
Dakikada Titreşim Sayısı	6000-11000 tit/dk
Kağıt Ölçüsü	230 x 115 mm
Ağırlık	2,3 Kg
Koli Adedi	8

GÖNYE KESME MAKİNALARI



Güçü	
W	
1900 W	
Yüksüz Hızı	Bıçak Çapı
4500 dev/dk	255x25.4 / 30 mm
90° Kesme Kapasitesi	45° Kesme Kapasitesi
55x125 mm	45x80 mm

KLK1512

415 \$

Güçü	1900 W
Yüksüz Hızı	4500 dev/dk
Bıçak Çapı	255 x 25.4 / 30 mm
Maksimum Kesme 0°/0°	55x125 mm
Maksimum Kesme 0°/45°	55x80 mm
Maksimum Kesme 45°/0°	45x125 mm
Maksimum Kesme 45°/45°	45x80 mm
Tabla Kesim Kapasitesi	42 mm
Mil Kilidi	<input checked="" type="checkbox"/>
Ağırlık	20.5 kg
Koli Adedi	1

Aksesuar
1 adet ahşap testeresi



Güçü	
W	
2200 W	
Yüksüz Hızı	Bıçak Çapı
3800 dev/dk	300x30 mm
90° Kesme Kapasitesi	45° Kesme Kapasitesi
105x330 mm	58/50x235 mm

KLK1515

530 \$

Güçü	2200 W
Yüksüz Hızı	3800 dev/dk
Bıçak Çapı	300 x 30 mm
Maksimum Kesme 0°/0°	105x330 mm
Maksimum Kesme 0°/45°	58-50x330 mm
Maksimum Kesme 45°/0°	105x235 mm
Maksimum Kesme 45°/45°	58-50x235 mm
Lazer / Mil Kilidi	<input checked="" type="checkbox"/> / <input checked="" type="checkbox"/>
Ağırlık	22.5 kg
Koli Adedi	1

Aksesuar
1 adet ahşap testeresi

LAZER KESİM ÇİZGİSİ
KAYIŞLI SİSTEM

KARIŞTIRICILAR



Aksesuar
1 adet karıştırıcı uç

Güçü	Yüksüz Hızı	Uç Tutucu
W		
1400 W	0-800 dev/dk	M14
	Karıştırma Kapasitesi	Uç Kapasitesi
	120 Lt	140 mm

DEVİR AYARLI

KLMX6211

115 \$

Elektronik / Sağ-Sol	<input checked="" type="checkbox"/> / <input type="checkbox"/>
Güçü	1400 W
Yüksüz Hızı	0-800 dev/dk
Vites	1
Uç Tutucu	M14
Uç Kapasitesi	140 mm
Karıştırma Kapasitesi	120 lt
Taşıma Çantası/Aksesuar	<input type="checkbox"/> / <input checked="" type="checkbox"/>
Ağırlık	6 kg
Koli Adedi	2



Aksesuar
1 adet karıştırıcı uç

Güçü	Yüksüz Hızı	Uç Tutucu
W		
1600 W	180-460 dev/dk 300-750 dev/dk	M14
	Karıştırma Kapasitesi	Uç Kapasitesi
	140 Lt	160 mm

DEVİR AYARLI
ÇİFT VİTES

KLMX6212

135 \$

Elektronik / Sağ-Sol	<input checked="" type="checkbox"/> / <input type="checkbox"/>
Güçü	1600 W
Yüksüz Hızı	180-460 / 300-750 dev/dk
Vites	2
Uç Tutucu	M14
Uç Kapasitesi	160 mm
Karıştırma Kapasitesi	140 lt
Taşıma Çantası/Aksesuar	<input type="checkbox"/> / <input checked="" type="checkbox"/>
Ağırlık	6 kg
Koli Adedi	2

ELEKTRİKLİ BETON VİBRATÖRÜ - HORTUMLARI



Yüksüz Hızı	Voltaj
2850 dev/dk	230 V / 50/60 Hz

KLBV2360

185 \$

Güçü	2300 W
Voltaj	230 V ~
Frekans	50/60 Hz
Yüksüz Hızı	2850 dev/dk
Ağırlık	14,5 kg
Koli Adedi	1



KLBVS43

90 \$

Şişe Çapı	43 MM
Hortum	6 M
Frekans	158 - 200 Hz
Ağırlık	13 kg
Koli Adedi	1

KLBVS55

100 \$

Şişe Çapı	55 MM
Hortum	6 M
Frekans	158 - 200 Hz
Ağırlık	18 kg
Koli Adedi	1

KAYNAK MAKİNALARI

MADE IN
ITALY



Çektığı Güç



7.0 kVa

Frekans



50/60 Hz

Akım Aralığı



10-160 A

Koruma Sınıfı



IP 21 S

KLMM160

260 \$

Giriş Voltajı	230 V
Frekans	50/60 Hz
Çektığı Güç	7.0 kVA
Akım Aralığı	10-160 A
Elektrot Çapı	1.6-4.0 mm
İzolasyon Sınıfı	H
Koruma Sınıfı	IP 21 S
Ağırlık	4.3 kg
Koli Adedi	2

/// SICAK BAŞLANGIÇ

/// 3.25 MM ELEKTRODU
SÜREKLİ YAKAR

MADE IN
ITALY



Çektığı Güç



8.0 kVa

Frekans



50/60 Hz

Akım Aralığı



15-200 A

Koruma Sınıfı



IP 21 S

KLMM200

320 \$

Giriş Voltajı	230 V
Frekans	50/60 Hz
Çektığı Güç	8.0 kVA
Akım Aralığı	15-200 A
Elektrot Çapı	1.6-5.0 mm
İzolasyon Sınıfı	H
Koruma Sınıfı	IP21S
Ağırlık	5.2 kg
Koli Adedi	2

/// SICAK BAŞLANGIÇ

/// ANTI-STICK ÖZELLİĞİ

/// ELEKTRONİK GÖSTERGE

/// 4 MM ELEKTRODU
SÜREKLİ YAKAR

MADE IN
ITALY



Çektığı Güç



9.5 kVA

Frekans



50/60 Hz

Akım Aralığı



15-220 A

Koruma Sınıfı



IP 21 S

KLMM220

510 \$

Giriş Voltajı	230 V
Frekans	50/60 Hz
Çektığı Güç	9.5 kVA
Akım Aralığı	15-220 A
Elektrot Çapı	1.6-5.0 mm
İzolasyon Sınıfı	H
Koruma Sınıfı	IP21S
Ağırlık	7.2 kg
Koli Adedi	1

/// SICAK BAŞLANGIÇ

/// ANTI-STICK ÖZELLİĞİ

/// ELEKTRONİK GÖSTERGE

/// 220 A'DE 100% VERİMLİLİK*

/// 1.6-5 MM ÇAPINDAKİ
ELEKTROTLARDA SÜREKLİ
ÇALIŞMA PERFORMANSI*

* İdeal şartlar altında
** Kablosu fişsizdir.



**MADE IN
ITALY**



Çektiği Güç



5.5 kVa

Frekans



50/60 Hz

Akım Aralığı



10-160 A

Koruma Sınıfı





IP 21 S

KLMIG160

600 \$

Giriş Voltajı	230 V
Frekans	50/60 Hz
Çektiği Güç	5.5 kVA
Akım Aralığı	10-160 A
Elektrot Çapı	1.6-3.2 mm
Yüksüz Voltaj	MIG 72 V TIG 13 V
Koruma Sınıfı	IP 21 S
Ağırlık	11.1 kg
Koli Adedi	1

Tel Tipi	SG2	INOX	FLUX
Tel Çapı	0,6-1,0 mm	0,6-1,0 mm	0,8-0,9 mm

TIGLIFT 
MIG 
MMA 

5 KG TEL

JENERATÖRLE KULLANILABİLİR

TERMOSTATİK KONTROL

**MADE IN
ITALY**



Çektiği Güç



8.2 kVa

Frekans



50/60 Hz

Akım Aralığı



10-200 A

Koruma Sınıfı





IP 21 S

KLMIG200

850 \$

Giriş Voltajı	230 V
Frekans	50/60 Hz
Çektiği Güç	8.2 kVA
Akım Aralığı	10-200 A
Elektrot Çapı	1.6-5.0 mm
Yüksüz Voltaj	MIG 87 V MMA 87 V TIG 13 V
Koruma Sınıfı	IP 21 S
Ağırlık	12.1 kg
Koli Adedi	1

Tel Tipi	SG2	INOX	FLUX
Tel Çapı	0,6-1,2 mm	0,6-1,0 mm	0,8-0,9 mm

TIGLIFT 
MIG 
MMA 

5 KG TEL

JENERATÖRLE KULLANILABİLİR

TERMOSTATİK KONTROL

2T - 4T MODUNDA ÇALIŞMA

GAZ ALTI KAYNAK MAKİNALARI

MADE IN
ITALY



Çektiği Güç 6.4 kVa	Frekans 50/60 Hz
Akım Aralığı 10-200 A	Koruma Sınıfı IP 21 S

KLTIG200

920 \$

Giriş Voltajı	230 V
Frekans	50/60 Hz
Çektiği Güç	MMA 6.9 kVA TIG 6.4 kVA
Akım Aralığı	MMA 10-160 A TIG 10-200 A
Elektrot Çapı	1.6-4.0 mm
Yüksüz Voltaj	71 V
Koruma Sınıfı	IP 21 S
Ağırlık	7 kg
Koli Adedi	1

13 MM 35-50 SOKET

JENERATÖRLE KULLANILABİLİR

TERMOSTATİK KONTROL

TIGHF
TIGPULSE
MMA

MADE IN
ITALY



Çektiği Güç 9.5 kVa	Frekans 50/60 Hz
Akım Aralığı 10-240 A	Koruma Sınıfı IP 21 S

KLMIG200X

1.400 \$

Giriş Voltajı	230 V
Frekans	50/60 Hz
Çektiği Güç	MIG 9.5 kVA MMA 8.7 kVA TIG 6.3 kVA
Akım Aralığı	MIG 20-240 A MMA/TIG 10-200 A
Elektrot Çapı	1.6-5.0 mm
Yüksüz Voltaj	MIG/MMA 87 V TIG 13 V
Koruma Sınıfı	IP 21 S
Ağırlık	27.9 kg
Koli Adedi	1

Tel Tipi	SG2	INOX	FLUX
Tel Çapı	0,6-1,2 mm	0,6-1,0 mm	0,8-0,9 mm

15 KG TEL

JENERATÖRLE KULLANILABİLİR

TERMOSTATİK KONTROL

2T - 4T MODUNDA ÇALIŞMA

TIGLIFT
MIG
MMA

İNVERTÖR GAZSIZ GAZ ALTI KAYNAK MAKİNASI - KAYNAK TELİ AKISI**MADE IN ITALY****KLAFT08 22 \$**

Tel Çapı	0,8 mm
Tel Tipi	FLUX
Ağırlık	1 kg
Makara Çapı	100 mm



Çektiği Güç



3,5 kVa - 2,6 kVa

Frekans



50/60 Hz

Akım Aralığı



15-95 A

Koruma Sınıfı



IP 21 S

KL MIG100**315 \$**

Giriş Voltajı	230 V
Frekans	50/60 Hz
Çektiği Güç	3,5 kVA 2,6 kVA
Akım Aralığı	15-95 A
Yüksüz Voltaj	47 V
Koruma Sınıfı	IP 21 S
Ağırlık	5,8 kg
Koli Adedi	1

İNVERTÖRLE KULLANILABİLİR**TEL SÜRME HIZI AYARLANABİLİR*****GAZSIZ ÇALIŞIR****MIG****SYNERGIC**

Tel Tipi	FLUX
Tel Çapı	0,8-0,9 mm

İNVERTÖR PLAZMA KESME MAKİNASI**MADE IN ITALY**

Çektiği Güç



5,8 kVa

Frekans



50/60 Hz

Akım Aralığı



15-40 A

Koruma Sınıfı



IP 21 S

KL PLS40**420 \$**

Giriş Voltajı	230 V
Frekans	50/60 Hz
Çektiği Güç	5,8 kVA
Akım Aralığı	15-40 A
Maks Kesme Kalınlığı	10 mm
Yüksüz Voltaj	270 V
Koruma Sınıfı	IP 21 S
Ağırlık	5,3 kg
Koli Adedi	1

İNVERTÖRLE KULLANILABİLİR

KOMPRESÖRLER



Motor Gücü	Tank Kapasitesi	Hava Giriş Kapasitesi
		
2 Hp / 1.5 Kw	24 Lt	210 lt/dk

- ÇİFT HAVA ÇIKIŞI
- TEK SİLİNDİR
- 24 LİTRE TANK
- MOTOR TERMİK KORUMA

KLK25

165 \$

Motor Gücü	2 Hp
Voltaj	230 V / 50 Hz
Çalışma Basıncı	8 Bar / 116 psi
Hava Giriş Kapasitesi	210 lt/dk
Tank Kapasitesi	24 lt
Motor Devir Hızı	2850 dev/dk
Gürültü Düzeyi	LwA = 93 dB(A)
Silindir Sayısı	1
Ağırlık	25 Kg
Koli Adedi	1



Motor Gücü	Tank Kapasitesi	Hava Giriş Kapasitesi
		
2 Hp / 1.5 Kw	50 Lt	210 lt/dk

KLK50

210 \$

Motor Gücü	2 Hp
Voltaj	230 V / 50 Hz
Çalışma Basıncı	8 Bar / 116 psi
Hava Giriş Kapasitesi	210 lt/dk
Tank Kapasitesi	50 lt
Motor Devir Hızı	2850 dev/dk
Gürültü Düzeyi	LwA = 93 dB(A)
Silindir Sayısı	1
Ağırlık	34 Kg
Koli Adedi	1

- ÇİFT HAVA ÇIKIŞI
- TEK SİLİNDİR
- 50 LİTRE TANK
- MOTOR TERMİK KORUMA



Motor Gücü	Tank Kapasitesi	Hava Giriş Kapasitesi
		
3 Hp / 2.2 Kw	100 Lt	300 lt/dk

KLK100

490 \$

Motor Gücü	3 Hp
Voltaj	230 V / 50 Hz
Çalışma Basıncı	8 Bar / 116 psi
Hava Giriş Kapasitesi	300 lt/dk
Tank Kapasitesi	100 lt
Motor Devir Hızı	950 dev/dk
Gürültü Düzeyi	LwA = 95 dB(A)
Silindir Sayısı	2
Ağırlık	73 Kg
Koli Adedi	1

- ÇİFT HAVA ÇIKIŞI
- ÇİFT SİLİNDİR
- 100 LİTRE TANK
- MOTOR TERMİK KORUMA



1 Hp



8 lt



131 lt/dk

SESSİZ
YAĞSIZ, ÇİFT SİLİNDİR

KLK8S**165 \$**

Güçü	1 Hp
Voltaj	230 V / 50 Hz
Çalışma Basıncı	8 Bar
Hava Giriş Kapasitesi	131 lt/dk
Tank Kapasitesi	8 lt
Motor Devir Hızı	1400 dev/dk
Silindir	2
Ağırlık	17,2 kg
Koli Adedi	1



1 Hp



24 lt



126 lt/dk

SESSİZ
YAĞSIZ, ÇİFT SİLİNDİR
ÇİFT HAVA ÇIKIŞI

KLK25S**185 \$**

Güçü	1 Hp
Voltaj	230 V / 50 Hz
Çalışma Basıncı	8 Bar
Hava Giriş Kapasitesi	126 lt/dk
Tank Kapasitesi	24 lt
Motor Devir Hızı	1400 dev/dk
Silindir	2
Ağırlık	20 kg
Koli Adedi	1



1 Hp



50 lt



126 lt/dk

SESSİZ
YAĞSIZ, ÇİFT SİLİNDİR
ÇİFT HAVA ÇIKIŞI

KLK50S**225 \$**

Güçü	1 Hp
Voltaj	230 V / 50 Hz
Çalışma Basıncı	8 Bar
Hava Giriş Kapasitesi	126 lt/dk
Tank Kapasitesi	50 lt
Motor Devir Hızı	1400 dev/dk
Silindir	2
Ağırlık	30 kg
Koli Adedi	1

SESSİZ KOMPRESÖRLER

Motor Gücü



2x1 Hp

Tank Kapasitesi



50 lt

Hava Giriş Kapasitesi



262 lt/dk



KLK50S2

340 \$

Güçü	2x1 Hp
Voltaaj	230 V /50 Hz
Çalışma Basıncı	8 Bar
Hava Giriş Kapasitesi	262 lt/dk
Tank Kapasitesi	50 lt
Motor Devir Hızı	1400 dev/dk
Silindir	4
Ağırlık	36 kg
Koli Adedi	1

SESSİZ

YAĞSIZ, 4 SİLİNDİR

ÇİFT HAVA ÇIKIŞI

Motor Gücü



3 Hp

Tank Kapasitesi



100 Lt

Hava Giriş Kapasitesi



418 lt/dk



KLK103S

590 \$

Güçü	3 x 1 Hp
Voltaaj	230 V / 50 Hz
Çalışma Basıncı	8 Bar
Hava Giriş Kapasitesi	418 lt/dk
Tank Kapasitesi	100 lt
Motor Devir Hızı	1400 dev/dk
Silindir	3 x 2
Ağırlık	69 kg
Koli Adedi	1

SESSİZ

YAĞSIZ, 3 x 2 SİLİNDİRLİ

ÇİFT HAVA ÇIKIŞI

BASINÇLI YIKAMA MAKİNALARI

Motor Gücü
W
1600 W

Maks. Basınç
130 Bar

Su Sevk Miktarı
5.2 lt/dk

Durgun Sudan Çekme Özelliği



- SU FİLTRESİ**
- DETERJAN KİTİ**
- DURGUN SUDAN ÇEKME ÖZELLİĞİ**

**KLY1600****105 \$**

Voltaj	230 V / 50 Hz
Motor Gücü	1600 W
Maks. Basınç	130 Bar
Su Sevk Miktarı	312 lt/sa
Hortum Uzunluğu	5 m
Deterjan Kiti	✓
Su Filtresi	✓
Makaralı Hortum Toplama	—
Ağırlık	5.9 kg
Koli Adedi	1



Motor Gücü
W
2200 W

Maks. Basınç
160 Bar

Su Sevk Miktarı
5.6 lt/dk

Durgun Sudan Çekme Özelliği



- SU FİLTRESİ**
- DETERJAN KİTİ**
- MAKARALI HORTUM TOPLAMA**
- DURGUN SUDAN ÇEKME ÖZELLİĞİ**

**KLY2200****160 \$**

Voltaj	230 V / 50 Hz
Motor Gücü	2200 W
Maks. Basınç	160 Bar
Su Sevk Miktarı	336 lt/sa
Hortum Uzunluğu	5 m
Deterjan Kiti	✓
Su Filtresi	✓
Makaralı Hortum Toplama	✓
Ağırlık	8.6 Kg
Koli Adedi	1



Motor Gücü
W
2500 W

Maks. Basınç
170 Bar

Su Sevk Miktarı
6.5 lt/dk

Durgun Sudan Çekme Özelliği



- SU FİLTRESİ**
- DETERJAN KİTİ**
- MAKARALI HORTUM TOPLAMA**
- DURGUN SUDAN ÇEKME ÖZELLİĞİ**

**KLY2500****210 \$**

Voltaj	230 V / 50 Hz
Motor Gücü	2500 W
Maks. Basınç	170 Bar
Su Sevk Miktarı	390 lt/sa
Hortum Uzunluğu	6 m
Deterjan Kiti	✓
Su Filtresi	✓
Makaralı Hortum Toplama	✓
Ağırlık	10.3 Kg
Koli Adedi	1

ELEKTRİKLİ VİNÇLER



500 W



125 / 250 Kg



10 / 20 m

MAKSİMUM 250 KG KALDIRMA

KLV125

110 \$

Güç	500 W
Voltaj	230 V / 50 Hz
Kaldırma Kapasitesi	125 / 250 Kg
Kaldırma Yüksekliği	10 / 20 m
Ağırlık	11 kg
Koli Adedi	2



1000 W



250 / 500 Kg



10 / 20 m

MAKSİMUM 500 KG KALDIRMA

KLV250

155 \$

Güç	1000 W
Voltaj	230 V / 50 Hz
Kaldırma Kapasitesi	250 / 500 Kg
Kaldırma Yüksekliği	10 / 20 m
Ağırlık	176 kg
Koli Adedi	2



1300 W



400 / 800 Kg



10 / 20 m

MAKSİMUM 800 KG KALDIRMA

KLV400

185 \$

Güç	1300 W
Voltaj	230 V / 50 Hz
Kaldırma Kapasitesi	400 / 800 Kg
Kaldırma Yüksekliği	10 / 20 m
Ağırlık	20.4 kg
Koli Adedi	2



1900 W



600 / 1200 Kg



10 / 20 m

MAKSİMUM 1200 KG KALDIRMA

KLV600

300 \$

Güç	1900 W
Voltaj	230 V / 50 Hz
Kaldırma Kapasitesi	600 / 1200 Kg
Kaldırma Yüksekliği	10 / 20 m
Ağırlık	33.8 Kg
Koli Adedi	1

ELEKTRİKLİ ÇİVİ/ZIMBA ÇAKMA MAKİNALARI

15-16 mm



8-16 mm



20 Adet/dk

Kartuş
KapasitesiÇivi: 80
Zimba: 100**KLZC6030E****35 \$**

Voltaj	230 V / 50 Hz
Zimba Uzunluğu	8-16 mm
Çivi Uzunluğu	15-16 mm
Kartuş Kapasitesi	Çivi: 80 Adet Zimba: 100 Adet
Vuruş Hızı	20 adet/dk
Ağırlık	1.2 kg
Koli Adedi	10

Tüm tip 53 Model zimbalar ile uyumludur.(Makine kapasitesine göre 8-16mm aralığında)
Tüm F TİPİ (kesik başlı) çiviler ile uyumludur. (Makine kapasitesine göre 15mm yada 16mm)
KLZC Serisi elektrikli çivi/zimba çakma makineleri aksesuarları için "AKSESUARLAR" bölümüne (Sy: 92) bakınız.



15-32 mm



15-25 mm



20 Adet/dk

Kartuş
KapasitesiÇivi: 100
Zimba: 100**KLZC6041E****60 \$**

Voltaj	230 V / 50 Hz
Zimba Uzunluğu	15-25 mm
Çivi Uzunluğu	15-32 mm
Kartuş Kapasitesi	Çivi: 100 Adet Zimba: 100 Adet
Vuruş Hızı	20 adet/dk
Ağırlık	1.7 kg
Koli Adedi	6

Tüm 90 SERİSİ zimbalar ile uyumludur. (Makine Kapasitesine göre 15-25mm aralığında)
Tüm F TİPİ (kesik başlı) çiviler ile uyumludur. (Makine kapasitesine göre 15-32mm aralığında)
KLZC Serisi elektrikli çivi/zimba çakma makineleri aksesuarları için "AKSESUARLAR" bölümüne (Sy: 92) bakınız.



HAVALI ÇİVİ ÇAKMA MAKİNALARI



Çivi Çapı
0.63 mm



Çivi Uzunluğu
12-22 mm



Kartuş Kapasitesi
100 Çivi

KLCT622P

70 \$

Kartuş Kapasitesi	100 Çivi
Çivi Tipi	Başsız
Çivi Çapı	0.63 mm
Çivi Uzunluğu	12-22 mm
Taşıma Çantası	✓
Ağırlık	0.7 kg
Koli Adedi	10



Çivi Çapı
1.25 mm



Çivi Uzunluğu
10-32 mm



Kartuş Kapasitesi
100 Çivi

KLCT32F

88 \$

Kartuş Kapasitesi	100 Çivi
Çivi Tipi	Kesik Başlı
Çivi Çapı	1.25 mm
Çivi Uzunluğu	10-32 mm
Taşıma Çantası	✓
Ağırlık	1.1 kg
Koli Adedi	6



Çivi Çapı
1.25 mm



Çivi Uzunluğu
20-50 mm



Kartuş Kapasitesi
100 Çivi

KLCT50F

100 \$

Kartuş Kapasitesi	100 Çivi
Çivi Tipi	Kesik Başlı
Çivi Çapı	1.25 mm
Çivi Uzunluğu	20-50 mm
Taşıma Çantası	✓
Ağırlık	1.3 kg
Koli Adedi	6

KLCT Serisi Havalı Çivi Çakma Makineleri Aksesuarları için "AKSESUARLAR" Bölümüne (Sy: 92) bakınız.

HAVALI ÇİVİ/ZIMBA ÇAKMA MAKİNASI



Çivi Çapı
1.25 mm



Çivi Uzunluğu
20-50 mm



Kartuş Kapasitesi
Çivi: 100
Zimba: 100



Zimba Genişliği
5.7 mm



Zimba Uzunluğu
16-40 mm

KLZCT509040

120 \$

Kartuş Kapasitesi	100 Çivi / 100 Zimba
Çivi Tipi	Kesik Başlı
Çivi Çapı / Zimba Genişliği	1.25 / 5.7 mm
Çivi / Zimba Uzunluğu	20-50 / 16-40 mm
Taşıma Çantası	✓
Ağırlık	1.5 kg
Koli Adedi	5

KLZCT509040 Havalı Çivi/Zimba Çakma Makinesi Aksesuarları için "AKSESUARLAR" Bölümüne (Sy: 92) bakınız.

HAVALI ZIMBA ÇAKMA MAKİNALARI



KLZT8016H

70 \$

Kartuř Kapasitesi	150 Zimba
Zimba Geniřliđi	12.8 mm
Zimba Uzunluđu	6-16 mm
Tařıma Çantası	✓
Ađırlık	0.9 kg
Koli Adedi	10



KLZT9040H

120 \$

Kartuř Kapasitesi	100 Zimba
Zimba Geniřliđi	5.7 mm
Zimba Uzunluđu	16-40 mm
Tařıma Çantası	✓
Ađırlık	1.5 kg
Koli Adedi	5



KLZT851N

185 \$

Kartuř Kapasitesi	80 Zimba
Zimba Geniřliđi	10.8 mm
Zimba Uzunluđu	18-51 mm
Tařıma Çantası	✓
Ađırlık	3.2 kg
Koli Adedi	5



KLZT9240H

155 \$

Kartuř Kapasitesi	180 Zimba
Zimba Geniřliđi	8.6 mm
Zimba Uzunluđu	16-40 mm
Tařıma Çantası	✓
Ađırlık	2.0 kg
Koli Adedi	5

HAVALI DARBELİ SOMUN SIKMA/SÖKMELER



Uç Kovanı 1/2 "	Maksimum Tork 340 Nm	Yüksüz Hızı 7000 dev/dk
	Çekiç Sistemi Tek Çekiç	Hava Girişi 1/4"

KLHA403

38 \$

Maksimum Tork	340 Nm
Uzunluk	205 mm
Yüksüz Hızı	7000 dev/dk
Çekiç Sistemi	Tek Çekiç
Hava Girişi	1/4"
Uç Kovanı	1/2"
Ağırlık	2.2 kg
Koli Adedi	10



Uç Kovanı 3/4"	Maksimum Tork 678 Nm	Yüksüz Hızı 4500 dev/dk
	Çekiç Sistemi Tek Çekiç	Hava Girişi 1/4"

KLHA0740

80 \$

Maksimum Tork	678 Nm
Uzunluk	247 mm
Yüksüz Hızı	4500 dev/dk
Çekiç Sistemi	Tek Çekiç
Hava Girişi	1/4 "
Uç Kovanı	3/4"
Ağırlık	4.5 kg
Koli Adedi	5



Uç Kovanı 1"	Maksimum Tork 3200 Nm	Yüksüz Hızı 3200 dev/dk
	Çekiç Sistemi Çift Çekiç	Hava Girişi 1/2"

KLHA9981

345 \$

Maksimum Tork	3200 Nm
Uzunluk	582 mm
Yüksüz Hızı	3200 dev/dk
Çekiç Sistemi	Tek Çekiç
Hava Girişi	1/2 "
Uç Kovanı	1"
Ağırlık	16.5 kg
Koli Adedi	1

HAVALI DARBELİ SOMUN SIKMA/SÖKME SETİ



Uç Kovanı 1/2 "	Maksimum Tork 340 Nm	Yüksüz Hızı 7000 dev/dk
	Çekiç Sistemi Tek Çekiç	Hava Girişi 1/4"

KLHA403K

55 \$

Maksimum Tork	340 Nm
Uzunluk	205 mm
Yüksüz Hızı	7000 dev/dk
Çekiç Sistemi	Tek Çekiç
Hava Girişi	1/4"
Uç Kovanı	1/2"
Ağırlık	2.2 kg
Koli Adedi	5

HAVALI CIRCIR



KLHA31

35 \$

Maksimum Tork	67 Nm
Uzunluk	263 mm
Yüksüz Hızı	1600 dev/dk
Hava Girişi	1/4"
Uç Kovanı	1/2"
Ağırlık	1.2 kg
Koli Adedi	20

HAVALI TORNAVİDA



KLHA802

60 \$

Kapasite	6 mm
Çalışma Torku	3-9 Nm
Uzunluk	200 mm
Yüksüz Hızı	1800 dev/dk
Hava Girişi	1/4"
Uç Kovanı	1/4"
Ağırlık	1.1 kg
Koli Adedi	10

HAVALI MATKAP



KLHA705

33 \$

Mandren Kapasitesi	10 mm
Sağ-Sol	✓
Uzunluk	183 mm
Yüksüz Hızı	1800 dev/dk
Hava Girişi	1/4"
Ağırlık	1.1 kg
Koli Adedi	10

HAVALI ÇEKİÇ KESKİ MAKİNASI



KLHA0101RK

20 \$

Uç Giriş Çapı	10.4 mm
Piston Stroku	41 mm
Vuruş Adedi	5000 vur/dk
Darbe Gücü	7 J
Uzunluk	134 mm
Hava Girişi	1/4"
Ağırlık	1.4 kg
Koli Adedi	10

HAVALI KALIPÇI TAŞLAMA



KLHA512

18 \$

Pens Ölçüsü	6 mm
Uzunluk	168 mm
Yüksüz Hızı	22000 dev/dk
Egzos	Arkadan
Hava Girişi	1/4"
Ağırlık	0.6 kg
Koli Adedi	20

HAVALI EKSANTRİK DAİRESEL ZIMPARA



KLHA603V6

45 \$

Disk Çapı / Eksantrik	150 / 2.5 mm
Diş Ölçüsü	5/16" x 24 UNF
Uzunluk	175 mm
Yüksüz Hızı	9000 dev/dk
Hava Girişi	1/4"
Ağırlık	11 kg
Koli Adedi	10

Aksesuar
Toz hortumu, toz maskesi

HAVALI AVUÇ TAŞLAMA



KLHA185

60 \$

Disk Çapı	125 mm
Uzunluk	225 mm
Yüksüz Hızı	11000 dev/dk
Hava Girişi	1/4"
Ağırlık	1.7 kg
Koli Adedi	10

HAVALI POP PERÇİN PENSESİ



KLHA0810

60 \$

Kapasite	5 mm
Uzunluk	225 mm
Hava Girişi	1/4"
Ağırlık	1.7 kg
Koli Adedi	10

HAVALI GRES TABANCASI**KLHA843****28 \$**

Kapasite	500 cc
Hava Girişi	1/4"
Ağırlık	1.3 kg
Koli Adedi	10

HAVALI SİLİKON TABANCASI**KLHA9907****19 \$**

Hava Girişi	1/4"
Koli Adedi	10

/// SİLİKON KARTUŞLARI İÇİN UYGUNDUR.

KL **PRO**
III®

Gücün Ustası, Ustanın Gücü!

A K S E S U A R L A R

/// BİTS UÇ SETİ



Ürün Kodu	Açıklama	Fiyat (USD)
KLBS30A	31 Parça Bits Uç Seti Torx Uç Dişi - T5, T6, T8, 2 x T10, 2 x T15, 2 x T20, T25, L= 25 mm Allen Uç - 2, 3, 4, 5, 6 mm, L= 25 mm Düz Uç - 2.5, 3, 4, 5, 6 mm, L= 25 mm Pozidriv Uç - PZ0, PZ1, PZ2, PZ3, PZ4, L= 25 mm Yıldız Uç - PH0, PH1, PH2, PH3, PH4, L= 25 mm Manyetik Uç Tutucu	4,00 - \$

/// BETON DELME UÇ SETİ



Ürün Kodu	Açıklama	Fiyat (USD)
KLUS5A	Beton Delme Uç Seti Uç Seti - 4, 5, 6, 8, 10 mm	5,50 - \$

/// DELME & VIDALAMA SETİ



Ürün Kodu	Açıklama	Fiyat (USD)
KLUS44A	44 Parça Delme & Vidalama Seti Ahşap Delme Uç - 3, 4, 5, 6, 8 mm Metal Delme Uç - 1, 1.5, 2, 2.5, 3, 3.5, 4, 4.5, 5, 5.5, 6 mm Beton Delme Uç - 4, 5, 6, 8 mm Torx Uç - T10, T15, T20, T25, T27, T30, T40 mm, L= 25 mm Düz Uç - 4, 5, 6 mm, L=25 mm / 4, 5 mm, L= 50 mm Pozidriv Uç - PZ0, PZ1, PZ2, PZ3, PZ4, L= 25 mm Yıldız Uç - PH1, PH2, L= 50 mm PH1, PH2, PH3, L= 25 mm Manyetik Uç Tutucu Ölçü Plastığı	16,00 - \$

/// MAKİNA BIÇAKĞI



TİLKİ KUYRUĞU TESTERE BIÇAKĞI

Parça Kodu	Açıklama	Paket Adedi	Fiyatı
KLTLT300	Paslanmaz Tilki Kuyruğu Testere Biçakğı	3	9,50 \$

ZİMBALAR

Parça Kodu	Ölçüsü	Uyumlu Makineler	Paket Adedi	Paket Fiyatı
KLZ08-5000	8 mm	KLZT8016H	5.000	2,50 \$
KLZ10 -4000	10 mm	KLZT8016H	4.000	2,50 \$
KLZ12-3000	12 mm	KLZT8016H	3.000	2,50 \$
KLZ14-3000	14 mm	KLZT8016H	3.000	2,50 \$
KLZ16-2250	16 mm	KLZT8016H	2.250	2,50 \$
KLZ20-5000	20 mm	KLZT9040H, KLZC6041E, KLZCT509040	5.000	10,00 \$
KLZ32-5000	32 mm	KLZT9040H, KLZCT509040	5.000	14,00 \$
KLZ40-5000	40 mm	KLZT9040H, KLZCT509040	5.000	17,00 \$
KLZ20B-1260	20 mm	KLZT9240H	1.260	2,50 \$
KLZ30B-720	30 mm	KLZT9240H	720	2,50 \$
KLZ40B-630	40 mm	KLZT9240H	630	2,50 \$
KLZ5308	8 mm	KLZC6030E	2.000	1,60 \$
KLZ5310	10 mm	KLZC6030E	2.000	1,80 \$
KLZ5312	12 mm	KLZC6030E	2.000	2,10 \$
KLZ5314	14 mm	KLZC6030E	2.000	2,60 \$
KLZ5316	16 mm	KLZC6030E	2.000	3,20 \$
KLZ20N-675	20 mm	KLZT851N	675	2,50 \$
KLZ30N-525	30 mm	KLZT851N	525	2,50 \$
KLZ40N-375	40 mm	KLZT851N	375	2,50 \$
KLZ50N-300	50 mm	KLZT851N	300	2,50 \$

ÇİVİLER

Parça Kodu	Ölçüsü	Uyumlu Makineler	Paket Adedi	Paket Fiyatı
KLZ15F-5000	15 mm	KLZC6030E, KLZC6041E	5.000	4,00 \$
KLZ20F-5000	20 mm	KLZC6041E, KLCT32F, KLCT50F	5.000	5,00 \$
KLZ25F-5000	25 mm	KLZC6041E, KLCT32F, KLCT50F	5.000	6,00 \$
KLZ30F-5000	30 mm	KLZC6041E, KLCT32F, KLCT50F	5.000	7,00 \$
KLZ40F-5000	40 mm	KLCT32F, KLCT50F	5.000	9,00 \$
KLZ50F-5000	50 mm	KLCT32F, KLCT50F	5.000	11,00 \$
KLZ15P	15 mm	KLCT622P	2.000	2,00 \$
KLZ22P	22 mm	KLCT622P	2.000	2,70 \$

KL **ECO**
III®

*Gücün Kullanıcısı,
Kullanıcının Gücü!*

ŞARJLI DARBESİZ VİDALAMA/MATKAP



Aksesuar
13 Parça aksesuar



12 Volt



1.3 Ah



Li-Ion



10 mm



0-700 dev/dk



KE2213NM

38 \$

Elektronik / Sağ-Sol



Akü

12 V / 1.3 Ah Li-Ion

Maksimum Tork

19 Nm

Yüksüz Hızı

0-700 dev/dk

Mandren Kapasitesi

10 mm

Tork Kademesi

18+1

Taşıma Çantası / Çift Akü



Koli Adedi

10

ŞARJLI DARBELİ VİDALAMA/MATKAPLAR



Aksesuar
16 Parça aksesuar



12 Volt



2.0 Ah



Li-Ion



Çift Akü



10 mm



0-350/0-1350 dev/dk



KE2220DM-DB

63 \$

Elektronik / Sağ-Sol



Akü

12 V / 2.0 Ah Li-Ion

Maksimum Tork

23 Nm

Yüksüz Hızı

0-350/0-1350 dev/dk

Mandren Kapasitesi

10 mm

Tork Kademesi

21+3

Taşıma Çantası / Çift Akü



Koli Adedi

10

/// ŞARJLI DARBELİ VİDALAMA/MATKAPLAR



AVUÇ TAŞLAMA

Elektronik / Sağ-Sol	✓ / ✓
Güç	750 W
Disk Çapı	115 mm
Yüksüz Hızı	1200 dev/dk
Taşıma Çantası	✓

Güçü	Yüksüz Hızı	Disk Çapı
W	12000 dev/dk	115 mm
750 W		

/// GÜVENLİKLİ TETİK
/// YUMUŞAK BAŞLANGIÇ

KETM1875

115 \$

ŞARJLI DARBELİ MATKAP

Elektronik / Sağ-Sol	✓ / ✓
Akü	18 V / 1.5 Ah Li-Ion
Maksimum Tork	40 Nm
Yüksüz Hızı	0-400/0-1400 dev/dk
Mandren Kapasitesi	10 mm
Taşıma Çantası/Çift Akü	✓ / ✓

Akü	Mandren Kapasitesi	Yüksüz Hızı
Li-Ion	10 mm	0-400/0-1400 dev/dk

/// ÇİFT AKÜ



Aksesuar
42 Parça aksesuar

Voltaj	Amper	Akü
18 Volt	1.5 Ah	Li-Ion
	Mandren Kapasitesi	Yüksüz Hızı
	0.8-10 mm	0-350/0-1250 dev/dk



KE18DM-15

70 \$

Elektronik / Sağ-Sol	✓ / ✓
Akü	18 V / 1.5 Ah Li-Ion
Maksimum Tork	30 Nm
Yüksüz Hızı	0-350/0-1250 dev/dk
Mandren Kapasitesi	0.8-10 mm
Taşıma Çantası / Çift Akü	✓ / -
Koli Adedi	5



Aksesuar
42 Parça aksesuar

Voltaj	Amper	Akü
18 Volt	2.0 Ah	Li-Ion
	Mandren Kapasitesi	Yüksüz Hızı
	0.8-10 mm	0-350/0-1250 dev/dk



KE18DM-20DB

100 \$

Elektronik / Sağ-Sol	✓ / ✓
Akü	18 V / 2.0 Ah Li-Ion
Maksimum Tork	30 Nm
Yüksüz Hızı	0-350/0-1250 dev/dk
Mandren Kapasitesi	0.8-10 mm
Taşıma Çantası / Çift Akü	✓ / ✓
Koli Adedi	5

DARBELİ MATKAP



KE5513DM

28 \$

Elektronik / Sağ-Sol



Güçü

600 W

Yüksüz Hızı

0-3100 dev/dk

Mandren Kapasitesi

2-13 mm

Koli Adedi

10

PNÖMATİK MATKAP



Aksesuar
5 Parça aksesuar

KE8226PM

70 \$

Elektronik / Sağ-Sol



Güç

820 W

Yüksüz Hızı

0-1050 dev/dk

Darbe Oranı

0-4700 dar/dk

Darbe Gücü

2.8 J

Delme Kapasitesi

26 mm

Taşıma Çantası



Koli Adedi

4

AVUÇ TAŞLAMA



/// GÜVENLİK Lİ TETİK

/// YUMUŞAK BAŞLANGIÇ

KE75115AT

30 \$

Elektronik / Sağ-Sol



Güç

750 W

Disk Çapı

115 mm

Yüksüz Hızı

12000 dev/dk

Taşıma Çantası



Koli Adedi

6

DEVİR AYARLI AVUÇ TAŞLAMA



/// GÜVENLİK Lİ TETİK

/// YUMUŞAK BAŞLANGIÇ

KE90125AT

40 \$

Elektronik / Sağ-Sol



Güç

900 W

Disk Çapı

125 mm

Yüksüz Hızı

3000-11000 dev/dk

Taşıma Çantası



Koli Adedi

6

POLİSAJ MAKİNASI



KE12180PS

62 \$

Elektronik / Sağ-Sol	✓ / ✓
Güç	1200 W
Disk Çapı	180 mm
Yüksüz Hızı	600-3000 dev/dk
Taşıma Çantası	✓
Koli Adedi	4

BÜYÜK TAŞLAMALAR



KE20180BT

80 \$

Elektronik / Sağ-Sol	✓ / ✓
Güç	2000 W
Disk Çapı	180 mm
Yüksüz Hızı	8500 dev/dk
Taşıma Çantası	✓
Koli Adedi	2



KE20230BT

80 \$

Elektronik / Sağ-Sol	✓ / ✓
Güç	2000 W
Disk Çapı	230 mm
Yüksüz Hızı	6600 dev/dk
Taşıma Çantası	✓
Koli Adedi	2

GRAVÜR TAŞLAMA



KE135GT

42 \$

Elektronik / Sağ-Sol	✓ / ✓
Güç	135 W
Yüksüz Hızı	8000-33000 dev/dk
Taşıma Çantası	✓
Koli Adedi	8

Aksesuar
* 200 Parça Set
* Esnek Şaft

EKSANTRİK ZIMPARA



KE30125EZ

40 \$

Elektronik / Sağ-Sol	✓ / ✓
Güç	300 W
Zımpara Ölçüsü	125 mm
Dakikada Titreşim Sayısı	6000-13000 tit/dk
Taşıma Çantası	✓
Koli Adedi	8

DEKUPAJ TESTERE



KE4030DT

28 \$

Elektronik / Sağ-Sol	✓ / ✓
Güç	400 W
Yüksüz Hızı	500-3000 dev/dk
Açılı Kesim	45°
Kesme Kapasitesi	Ahşap: 65 mm Çelik: 6 mm Alüminyum: 20 mm
Taşıma Çantası	✓
Koli Adedi	10

DAİRE TESTERE



KE14185DAT

60 \$

Elektronik / Sağ-Sol	✓ / ✓
Güç	1400 W
Bıçak Çapı	185 mm
Motor Devir Gücü	4800 dev/dk
90° Kesim Derinliği	65 mm
Taşıma Çantası	✓
Koli Adedi	4

SICAK HAVA TABANCASI



Aksesuar
* 5 Parça Set

KE7202SH

24 \$

Elektronik / Sağ-Sol	✓ / ✓
Güç	2000 W
Sıcaklık	1.kad.: 450° C 2.kad.: 600° C
Hava Akımı	1.kad.: 300 lt/dk 2.kad.: 500 lt/dk
Taşıma Çantası	✓
Koli Adedi	8

LAZER METRE



/// ALAN ÖLÇÜMÜ
/// HACİM ÖLÇÜMÜ
/// PİSAGOR ÖLÇÜM FONKSİYONU

KE30LM

35 \$

Lazer Sınıfı	630-670 nm , 1<mW
Ölçme Hassasiyeti	± 3 mm
Ölçme Mesafesi	30 m
Pil	2 x 1.5 V AAA
Koli Adedi	10

KAYNAK MAKİNASI

MADE IN
ITALY



Çektği Güç 6.8 kVA/5.4 kW	Frekans 50/60 Hz	Akım Aralığı 15-160 A
		Koruma Sınıfı IP 21 S

- /// SICAK BAŞLANGIÇ
- /// ANTI - STICK
- /// SADECE 3.5 KG

KE160MMA

225 \$

Giriş Voltajı	230 V
Frekans	50/60 Hz
Çektği Güç	6.8 kVA
Akım Aralığı	15-160 A
Elektrot Çapı	1.6-4.0 mm
İzolasyon Sınıfı	H
Koruma Sınıfı	IP 21 S
Ağırlık	3.5 kg
Koli Adedi	1

KARIŞTIRICI



Aksesuar
1 adet karıştırıcı uç

Güçü 1600 W	Yüksüz Hızı 0-850 dev/dk	Uç Tutucu M14
	Karıştırma Kapasitesi 120 Lt	Uç Kapasitesi 140 mm

KE1622MX

75 \$

Elektronik / Sağ-Sol	<input checked="" type="checkbox"/> / <input type="checkbox"/>
Güçü	1600 W
Yüksüz Hızı	0-850 dev/dk
Uç Tutucu	M14
Uç Kapasitesi	140 mm
Karıştırma Kapasitesi	120 lt
Taşıma Çantası/Aksesuar	<input type="checkbox"/> / <input checked="" type="checkbox"/>
Ağırlık	4.6 kg
Koli Adedi	4

ŞARJ CİHAZLARI



KEK100



KEK108

Ürün Kodu	Voltaj	Çıkış Amperi	Liste Fiyatı
KEK100	12 V	0.4 A	6,00 \$
KEK108	18 V	1.5 A	10,00 \$

LI-ION AKÜLER



KEA1213



KEA181



KEA182

Ürün Kodu	Voltaj	Akü Kapasitesi	Liste Fiyatı
KEA1213	12 V	1.3 Ah	13,00 \$
KEA181	18 V	1.5 Ah	25,00 \$
KEA182	18 V	2 Ah	30,00 \$

ŞEHİR	SERVİS ADI	ADRES	TELEFON
KALE A.Ş. SERVİS YÖNETİM MÜDÜRLÜĞÜ		Defterdar Mah. Savaklar Cad. No:15 Edirnekapi, Eyüpsultan - İstanbul	0212 533 98 34
MERKEZ ÇÖZÜM SERVİS		Necip Fazıl Mah. Sarıkaya Sk. No:39/5 Ümraniye - İstanbul	0530 528 13 48
ADANA	Erol Teknik	Ulu Camii Mah. 25020 Sok.No:6/B Seyhan	(533) 362-2415
AFYONKARAHİSAR	Kardeş Bobinaj Elektrik	Veysel Karani Mah.1135 Sokak No:26/A Merkez	(532) 397-7904
AĞRI	Mak-Tek Servis ve El Aletleri	Kağızman Cad.Bülbül Sokak No:52 Merkez	(472) 215-7041
AKSARAY	Çelikler Hırdavat	Yeni San. Sit. 2023 Sok. No:1 Merkez	(537) 649-4170
ANKARA	Anı Makina	1199 Sokak No:28 Ostim Yeni Mahalle	(312) 354-7624
ANKARA	Aydin Bobinaj	1178.Sk (2. Sok.) No:89 Ostim Yeni Mahalle	(312) 354-2928
ANKARA	Gazi Teknik	Taştop Sokak No:75/A Siteler Altındağ	(312) 348-7989
ANTALYA	Antmak Elek.Bobinaj	Şafak Mah. Akdeniz San.Sit.5025 Sok. No:7 Kepez	(546) 203-3518
ANTALYA	Aydın Elektrik & Bobinaj	Narenciye Mah. Demirciler Sokak Torun Apt.24 - No:25 Kumluca Antaya	(544) 862-2981
ANTALYA	Çağ-Tek Makina	Cumhuriyet Mah.Eski San.Sit.664.Sk. No:29 Muratpaşa	(242) 343-2931
AYDIN	Enerji Teknik Bobinaj	Yeni Mah. Atatürk Bulvarı No:204/B Didim	(256) 811-4370
AYDIN	Özen Bobinaj	Ata Mah. Tepecik Bulvarı No: 39 Efeler	(256) 227-0707
BALIKESİR	Emek Bobinaj	17 Eylül Mahallesi Ş.İlhan Güncan Cad.No:20/B Bandırma	(536) 893-7289
BALIKESİR	Karesi Kaynak Merkezi	Paşaalani Mah. 31-46 Sk. No:15/A Karesi	(533) 200-1721
BİLECİK	Aea Arslan Mühendislik	Hürriyet Mah. Küçük Sanayi Sitesi 1.Etap 2.Sokak No:14	(228) 212-3535
BİNGÖL	Ümit Bobinaj	Ş.Mustafa Gündoğdu Mah. Bayındırlık Cad.No:38 Merkez	(544) 842-5800
BOLU	Garanti Bobinaj	Sanayi Sitesi 28.Blok No:2 Merkez	(374) 215-5123
BURSA	Altinel Bobinaj	Ulu Mah 2.Altıngül Sokak No 33/B Osmangazi Bursa	(224) 253-4446
BURSA	Cantürkler Bobinaj	Nilüfer Beşevler Küçük Sanayi Sitesi Parkoop. 48.Sk No:77 Nilüfer	(224) 441-4849
BURSA	Çağ Teknik Bobinaj	Mahmudiye Mah. Ertuğrulgazi Cad. Armağan Sok. No:21 İnegöl	(224) 715-5737
BURSA	Güney Kaynak	Beşevler Mah. Sinem(130) Sk.No:5 A/3 Nilüfer	(224) 363-1444
ÇANAKKALE	Adakale Bobinaj	Barbaros Mah. Reşat Tabak Sokak No:1/C Merkez Çanakkale	(506) 363-4910
ÇANAKKALE	Ovalı Bobinaj	Hamdibey Mah.İstiklal Cad. No:160 Biga	(286) 316-6550
ÇORUM	Emek Bobinaj	Küçük San. Sit. 23. Cad.No:5/C Merkez	(364) 234-6884
DENİZLİ	Örsler Bobinaj	Saraylar Mah. 171 Sok. Sedef Çarşısı No: 1/C Merkez Efendi	(258) 261-4274
DİYARBAKIR	Gama Elektrik	S.Eyyübi Mah. Urfa Yolu Üzeri Kale Koop. B Blok Altı No:33/B Merkez	(412) 237-3158
DÜZCE	Berke Makina	Kültür Mah. 793 Sok. No:10 Merkez	(380) 524-8383
DÜZCE	Beş Yıldız Servis Hizmetleri	Kültür Mah.Eski San.Çarşısı 792.Sok No:27 Merkez	(380) 514-7056
EDİRNE	Eray Bobinaj	Küçük Sanayi Sitesi 4. Blok No: 14 Merkez	(284) 225-2692
ELAZIĞ	Kalender Bobinaj	Sanayi Sitesi 11. Sok. No:46 Merkez	(424) 224-8501
ERZİNCAN	Bakircioğlu Elektrik Makine	Gülabibey Mah. Şehit Kenan Ardicı Cad. No:44/A Merkez	(446) 223-0959
ERZURUM	Tolga Makine	Bakırcı Mah. Cennet Çeşme Sk.Yaşam Apt. No:6/E Merkez	(442) 235-6364
ESKİŞEHİR	Es Elektrik Bobinaj	Şirintepe Mah. Kayacı Sokak No:1/B Tepebaşı Eskişehir	(542) 677-64 10
GAZİANTEP	Çalikoğlu Bobinaj	Sanayi Mah.60031 Nolu Cad. No:1 Şehitkamil Gaziantep	(342) 235 63 09
GAZİANTEP	Özdemir Bobinaj	Aydın Baba Mah.İlk Belediye Başkan Caddesi No 2/B Şahinbey	(342) 232-2281
GAZİANTEP	Umut Servislik Hizmetleri	Düztepe Mah. Ömer Battal Cad.No:49 Şahinbey	(342) 231-1733
HATAY	Bal Bobinaj	Yeni Sanayi Sitesi 5.Cadde 51/B Blok No:7 Antakya	(532) 693-6866
HATAY	Garanti Bobinaj	Güzelburç Mah. 2303 Sokak No:81 Antakya Hatay	(507) 822 3132
HATAY	Özdemir Bobinaj	Muradiye Mah. 320/1 Sokak No:29 İskenderun	(326) 616-5254
İSTANBUL	Altek Mekatronik	İçmeler Mah.Altunay Sok.No:1/A Tuzla	(216) 494-0343
İSTANBUL	Ard Makina Teknik Servis	İ.O.S.B. Demirciler San.Sit.Sosyal Tesis 2 Dış Kapı:1 İç Kapı:7 Başakşehir	(212) 548-2400
İSTANBUL	Ay-Par Elektrik	Sefaköy Fevzi Çakmak Mah.Ahmet Kocabıyık Sk. No:23-C K.Çekmece	(212) 580-9639
İSTANBUL	Eminoğlu Makina	Merve Mah.Halife Cad.No:77/A Yenidoğan Sancaktepe	(216) 311-1241



ŞEHİR	SERVİS ADI	ADRES	TELEFON
İSTANBUL	Erad Elektromekanik	Yeni Çamlıca Mah. Dursunbey Caddesi No:49/1-A Ataşehir İstanbul	(533) 601-1382
İSTANBUL	Ermak Grup Teknik Servis	Altınşehir Mah.Alemdağ Cad.No:626/A Ümraniye	(216) 540-4628
İSTANBUL	Er-Şah Makina	Halil Rif. P. Mh. Yüzer Hav. Sk. Perpa Tic. Mrk. BBlok MaviAvlu K:6 No:727 Şişli	(507) 025-7390
İSTANBUL	Fırat Dış Tic.Ltd.Şti	Tersane Cad. Zincirli Han Sok. Eyyübi Han No:3/A Karaköy	(212) 252-9343
İSTANBUL	Kardeşler Elektrik Bobinaj	Gürsel Mah. Kağıthane Cad.No:34/A Kağıthane	(212) 224-9754
İSTANBUL	Nur Elektromekanik	Gürpınar Mah. Durusu Cad.Beyza Apt. No:2A Beylikdüzü	(534) 491-7041
İSTANBUL	Osga Bobinaj ve Elektrik	Ali Paşa Mah.Fatih Sultan Mehmet Cad.Sancak Özsoy San.Sit.No:6/49 Silivri	(541) 362-2940
İSTANBUL	Sevnur Bobinaj	Esenşehir Mah. Nato Yolu Cad. No:185/A Dudullu Osb Ümraniye	(216) 527-8767
İSTANBUL	Trk Makina Bobinaj	Altay Çeşme Mah. Bağdat Cad.Adalı Sk.No: 8/ B Maltepe	(216) 305-4443
İSTANBUL	Turanmak Makine	Kavacık Mah.Özgür Cad.No:8/A Beykoz	(216) 425-6788
İSTANBUL	Zirve Teknik	Turgut Reis Mah. Fatih Bulvarı No:394/C Sultanbeyli	(216) 419-2433
İZMİR	İrfan Bobinaj	1310 Sk. No:41/B Çankaya Konak	(232) 425-3549
İZMİR	Kent Bobinaj	Küçük Çiğli Mah. Ata Sanayi Sitesi 8780/33 Sok. No:50 Çiğli	(232) 328-1033
İZMİR	Ulusal Teknik Servis	Gıda Çarşısı Baltalı İş Merkezi 1203 Sk. No:18-C Konak Yenisehir	(232) 469-3533
KAHRAMANMARAŞ	Bayram Bobinaj	Yavuz Selim Mah. Yeni San. Sit. 73004. Cad. No:31/A Dulkadiroğlu	(344) 231 08 26
KARABÜK	Damla Elektrik Bobinaj	Hürriyet Mah. Aktaş Cad. No: 17/B Merkez	(541) 241 78 01
KARAMAN	Mechanic Elektrik Bobinaj	Hamidiye Mah. 735.Sokak No:2 Merkez	(545) 965-4209
KASTAMONU	Teknik Bobinaj	İnönü Mah. İnebolu Cad.Sanayi Çarşısı No:132 Merkez	(366) 212-6226
KAYSERİ	Akın Elektrik Bobinaj	Ambar Ağaç İşleri Mah.29.Cad.No:84 Melikgazi	(352) 311-4174
KAYSERİ	Akın Elektrik	Sanayi Mah.6005.Cad.No:8/D Kocasinan	(352) 336-4123
KOCAELİ	Gülsoy Bobinaj	Sultan Orhan Mah. İlyasbey Cad.1111. Sok No: 5/1 Gebze	(262) 646-9249
KONYA	Sözenler Bobinaj	Fevzi Çakmak Mah. Kombassan Dükkanları 10562.Sk. No:8 Karatay	(332) 342-6318
KÜTAHYA	Kudret Bobinaj	Yeni Sanayi Sitesi 19.Sok. No: 30 Merkez	(537) 976-7904
MANİSA	Uslu Bobinaj	75. Yıl Mah. 5309 Sokak No:63/A Yunusemre Manisa	(539) 579-5957
MARDİN	Teknik Makina	Ravza Cad.46.Sk. Kanza Çarşısı 2.Kısım B/Blok Altı Zemin No:39 Artuklu	(542) 424-1819
MERSİN	ABC Mekatronik	Siteler Mah.Sanayi Sitesi 5682 Sk.No:3/B Akdeniz	(542) 667-2941
MERSİN	Coşkun Bobinaj	Siteler Mah. 5678 Sokak Sanayi Sitesi G-31 Blok No:4/K Akdeniz	(324) 337-3161
MERSİN	Flaş Hırdavat	Siteler Mah. San. Sit. 159.Cad. No:4/D Akdeniz	(324) 336-0232
NEVŞEHİR	Aken Elektrik	Yeni San. Sit. 8. Blok No:49 Merkez	(384) 213-1996
NİĞDE	Emek Motor	Eski San. Sit. 1.Blok No: 2 Merkez	(388) 232-8359
ORDU	Uzman Teknik	Karapınar Mah. 2.San.Sit.1153.Sok.No:15/A Merkez	(452) 232-1061
RİZE	Çemberci Bobinaj	Engindere Mah. Sanayi Sitesi F Blok No: 20 Merkez	(464) 217-4500
SAKARYA	İr Makina Elek. San. Tic. Ltd. Şti.	İstiklal Mah. Fevzi Paşa Cad. No:36 Serdivan Sakarya	(264) 279-0181
SAMSUN	Akış Bobinaj	Sanayi Sitesi Ulus Cad. No:31/B Merkez	(362) 238-0723
SAMSUN	Güven Bobinaj Atölyesi	Eski Sanayi Sitesi 29.Sok. No:6 Canik	(362) 228-8396
SIİRT	Seçkin Bobinaj	Özgen Cad. 911 Sokak No:10 Merkez Siirt	(542) 640-3250
SİVAS	Bayraktar Elektrik	Camii Kebir Mah. Mahkeme Çarşısı Cad. No: 40/C Merkez	(346) 221-4755
ŞANLIURFA	Ay Elektrik	Kadioğlu Mah.Vali Fuat Cad. Samsat Kapı Aşaroğlu Garajı No:7 Eyyübiye	(414) 215-7476
TEKİRDAĞ	Birkan Teknik	Şeyhsinan Mah. Ereğli Sok.Kılavuz İş Hanı No:2 Çorlu	(282) 654-5091
TEKİRDAĞ	Aygün Havalı Teknik	Hıdırağa Mah. Salih Omurtak Cad. Kara İbrahim Sk. No:4-6A Çorlu Tekirdağ	(534) 320-0203
TEKİRDAĞ	Çetin Elektrik Bobinaj	100.Yıl Mah. Mehmet İlhan Sokak No:12/1C Süleymanpaşa	(282) 263-8660
TEKİRDAĞ	Özyıl Elektrik	Küçük Sanayi Sit. Fevzipaşa Mah.Hayri Batur Cad. 6.Blok No:7-6/2 Çerkezköy	(282) 726-6704
TOKAT	Çetin Elektrik Bobinaj	Sanayi Sitesi Cami Altı No: 22 Merkez	(356) 214-6307
TRABZON	Saran Bobinaj	Değirmendere Mah.Rize Cad.Altın Sk. No:6 Ortahisar	(533) 479-1232
VAN	Kutlu Elektronik Ve Bobinaj	Ercişli Emrah Sokak Alçekiç Psj.No:20 İpekyolu	(432) 214-8313
ZONGULDAK	Aytekin Elektrik	Kışla San. Sit. I Blok No: 24 Karadeniz Ereğli	(372) 316-3971



Satın aldığınız **KLPRO, KLECO, HiKOKI** markalı ürünlerde geçerli www.kalemakina.com/3yilgaranti web sitesi üzerinden sisteme kayıt olmanız, fatura tarihi itibarıyla 15 gün içerisinde satın aldığınız ürünlerin model adı, satış fatura numarası ve fatura tarihi bilgilerini eksiksiz olarak girmeniz yeterli olacaktır.

HiKOKI
Gücün Profesyoneli, Profesyonelin Gücü!

KL PRO
Gücün Ustası, Ustanın Gücü!

KL ECO
Gücün Kullanıcısı, Kullanıcının Gücü!

KALE
Gücün Kalesi, Kale'nin Gücü!

KALE HIRDAVAT ve MAKİNA A.Ş.
Defterdar Mah. Savaklar Cad. No:15 Eyüpsultan / İSTANBUL

Tel: 0212 533 52 55
www.kalemakina.com